

# Chip Resistor Arrays CRB2A4E (Concave), CRC11A2E (Convex) Series

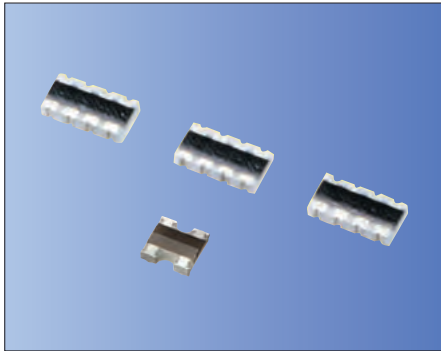

RoHS Compliant

Miniature chip resistor arrays have 4 and 2 resistor elements integrated as a single component.

## How to Order

CRB2A 4E 103 J H  
① ② ③ ④ ⑤

## Features

- Miniature (2.0×1.0mm) Resistor Arrays  
Max. 60% space saving compared with the use of standard chip array (3.2×1.6mm)
- 0.5mm Termination pitch (Same as IC lead-pin pitch)  
Easy designing of pattern layout and improve electrical characteristics for circuit

- ① Series (CRB2A: 2.0×1.0mm, concave termination, 4 elements)  
(CRC11A: 1.0×1.0mm, convex termination, 2 elements)
- ② Number of elements (4E: 4 elements)  
(2E: 2 elements)
- ③ Resistance Value (3 digits numbering)  
472 = 4.7kΩ, 103 = 10kΩ  
000 = 0Ω (Chip Jumper Array)
- ④ Tolerance
- ⑤ Packaging

\* Please consult combination of different resistance type

J	±5%	Blank	Chip Jumper Array
---	-----	-------	-------------------

\* 2mm pitch taping

Code	Form	Material	Packing unit
H	Taping	Paper	10000 pcs./ reel

- 4 element chip Resistors Array ————— CRB2A4E series (Concave Termination)
- 2 element chip Resistors Array ————— CRC11A2E series (Convex Termination)

## Dimensions

(Unit: mm)

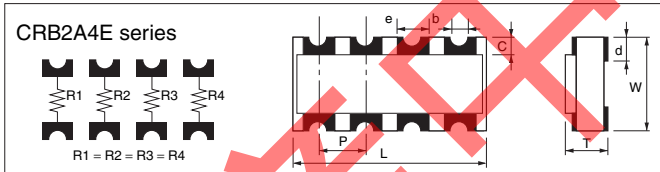

Code	L	W	T	P	b
Dimensions	2.0 <sup>+0.10</sup> / <sub>-0.10</sub>	1.0 <sup>+0.10</sup> / <sub>-0.10</sub>	0.4 <sup>+0.10</sup> / <sub>-0.10</sub>	0.5 typ.	φ0.15 typ.
Code	c	d	e		
Dimensions	0.2 <sup>+0.15</sup> / <sub>-0.15</sub>	0.25 <sup>+0.15</sup> / <sub>-0.15</sub>	0.25 typ.		

• No marking on chips.

(Unit: mm)

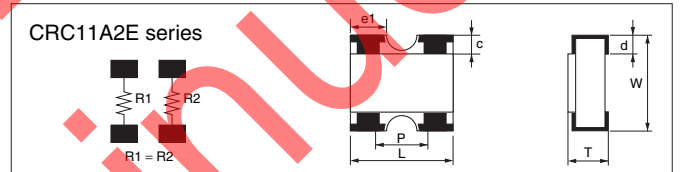

Code	L	W	T	P
Dimensions	1.00 <sup>+0.10</sup> / <sub>-0.10</sub>	1.00 <sup>+0.10</sup> / <sub>-0.10</sub>	0.35 <sup>+0.05</sup> / <sub>-0.05</sub>	0.65 typ.
Code	c	d	e1	
Dimensions	0.20 <sup>+0.15</sup> / <sub>-0.15</sub>	0.20 <sup>+0.15</sup> / <sub>-0.15</sub>	0.33 <sup>+0.10</sup> / <sub>-0.10</sub>	

• No marking on chips.

## Rating

Chip resistor arrays		Chip jumper array	
Item	Rating	Item	Rating
Rated power (70°C)	1/ 32W/ element	Rated current	1A
Max. working voltage	25V		
Max. Over-load voltage	50V		
Resistance value	10Ω to 1MΩ	Conductive resistance value	50mΩ max.
Tolerance	J: ±5%		
Working Temperature	-55 to +125°C		
Number of elements	4E: 4 elements, 2E: 2 elements		

\* Rated Voltage: √Rated power × Resistance value, whichever is less.

\* Standard Resistance Value: E-6 Series

\* Please contact sales engineer for any other requirements of the nominal resistance value and the tolerance.

8 element chip Resistor Array/ CRB6A8E Series (Concave Termination)

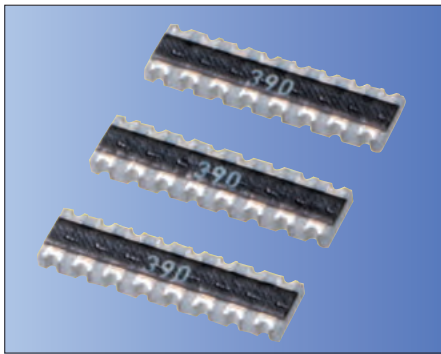

RoHS Compliant

Features

- Equal length conductors can be traced out from 0.8mm pitch termination

How to Order

CRB6A 8E 390 G U  
 ① ② ③ ④ ⑤

- ① Series CRB6A
- ② Number of elements  
8E = 8 elements
- ③ Resistance value  
3 digits numbering
- ④ Tolerance

G	±2%	J	±5%
---	-----	---	-----

- ⑤ Packaging

U	Taping plastic 4,000 pcs./ reel
---	---------------------------------

Rating

Chip Resistor Arrays	
Item	Rating
Rated power (70°C)	1/ 16W/ element
Max. working voltage*	50V
Max. over-load voltage	100V
Resistance value	10Ω to 1MΩ
Tolerance	G: ±2%, J: ±5%
Working temperature	-55 to +125°C
Number of elements	8E: 8 elements

\* Rated Voltage:  $\sqrt{\text{Rated power} \times \text{Resistance value}}$ , whichever is less.  
 \* Standard Resistance Value: E-6 Series  
 \* Please contact sales engineer for any other requirements of the nominal resistance value and the tolerance.

Dimensions

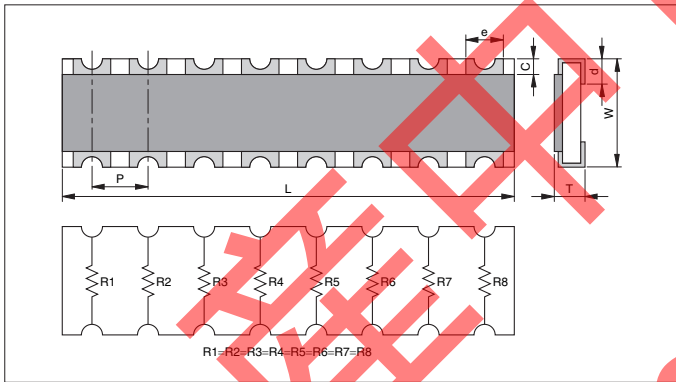

(Unit: mm)



Code	Dimensions
L	6.4±0.2
W	1.6±0.2
T	0.6±0.1
P	0.8 typ.
c	0.3±0.2
d	0.4±0.15
e (Top side)	0.5±0.1
e (Bottom side)	0.4±0.15

生 産 中 止  
 Discontinued Product

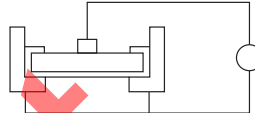
Electrical Characteristics

Item	Standard		Test Conditions									
	Resistor	Jumper	Resistor	Jumper								
DC Resistance	Within Initial Tolerance	50mΩ max.	Power Condition A (20°C, 65%RH)									
Temperature Characteristics	<table border="1"> <thead> <tr> <th>Resistance (Ω)</th> <th>TCR (ppm/ °C)</th> </tr> </thead> <tbody> <tr> <td>R &lt;10</td> <td>-100 to +600</td> </tr> <tr> <td>10 ≤ R ≤ 1M</td> <td>-250 to +250</td> </tr> <tr> <td>1M &lt; R</td> <td>-500 to +300</td> </tr> </tbody> </table>		Resistance (Ω)	TCR (ppm/ °C)	R <10	-100 to +600	10 ≤ R ≤ 1M	-250 to +250	1M < R	-500 to +300	Test Temperature: 25, 125 (°C) $\Delta R/R = R_2 - R_1 / R_1 \times 1 / T_2 - T_1 \times 10^6$ ΔR/R: Temp. Coefficient (ppm/ °C) T <sub>1</sub> : 25 (°C) T <sub>2</sub> : 125 (°C) R <sub>1</sub> : T <sub>1</sub> Resistance at (Ω) R <sub>2</sub> : T <sub>2</sub> Resistance at (Ω)	
	Resistance (Ω)	TCR (ppm/ °C)										
R <10	-100 to +600											
10 ≤ R ≤ 1M	-250 to +250											
1M < R	-500 to +300											
Short-time Overload	ΔR/R	± (2.0%+0.10Ω) max. of the initial value	50mΩ max.	(1) Apply 2.5×rated voltage for 5 sec. (2) Wait 30 minutes (3) Measure resistance								
	Visual	No evidence of mechanical damage intermittent overload		(1) 2A for 5 sec. (2) Wait 30 minutes (3) Measure resistance								
Intermittent Overload	ΔR/R	± (5%+0.1Ω) max. of the initial value	50mΩ max.	(1) Perform 10000 voltage cycles as follows: ON (2.5×rated voltage) 1 sec. OFF 25 sec. (2) Stabilization time 30 min. without loading (3) Measure resistance								
	Visual	No evidence of mechanical damage		(1) Perform 10000 current cycles as follows: ON (2A) 1 sec. OFF 25 sec. (2) Wait 30 minutes (3) Measure resistance								
Dielectric Withstanding Voltage	No evidence of mechanical damage		Apply 300VAC for 1 sec. 									
Insulation Resistance	10 <sup>8</sup> Ω min.		Apply 100V DC. 									

### Mechanical Characteristics

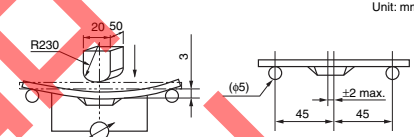
Item		Standard		Test Conditions	
		Resistor	Jumper	Resistor	Jumper
Terminal Strength	$\Delta R/R$	$\pm (1\%+0.05\Omega)$ max. of the initial value	50m $\Omega$ max.	Apply the load as show: Measure resistance during load application  Unit: mm 	
	Visual	No evidence of mechanical damage after loading			
Soldering Heat Resistance	$\Delta R/R$	$\pm (1\%+0.05\Omega)$ max. of the initial value	50m $\Omega$ max.	Immerse into molten solder at 260 $\pm$ 5 $^{\circ}$ C for 10 $\pm$ 1 sec. Stabilize component at room temperature for 1hr. Measure resistance.	
	Visual	No evidence of leaching			
Solderability		Coverage $\geq$ 95% each termination end		Immerse in Rogin Flux for 2 $\pm$ 0.5 sec. and in SN62 solder at 235 $\pm$ 5 $^{\circ}$ C for 2 $\pm$ 0.5 sec.	
Anti-Vibration Test	$\Delta R/R$	$\pm (1\%+0.1\Omega)$ max. of the initial value	50m $\Omega$ max.	2 hrs. each in X, Y and Z axis. (TTL 6hrs.) 10 to 55 Hz sweep in 1 min. at 1.5mm amplitude.	
	Visual	No evidence of mechanical damage			
Solvent Resistance	$\Delta R/R$	$\pm (0.5\%+0.05\Omega)$ max. of the initial value	50m $\Omega$ max.	Immerse in static state butyl acetate at 20 $^{\circ}$ C to 25 $^{\circ}$ C for 30 $\pm$ 5 sec. Stabilize component at room temperature for 30 min. then measure value.	
	Visual	No evidence of mechanical damage			

### Environmental Characteristics

Item		Standard		Test Conditions	
		Resistor	Jumper	Resistor	Jumper
Temperature Cycle	$\Delta R/R$	$\pm (1\%+0.05\Omega)$ max. of the initial value	50m $\Omega$ max.	1) Run 5 cycles as follows: -55 $\pm$ 3 $^{\circ}$ C for 30 min. 125 $\pm$ 3 $^{\circ}$ C for 30 min. Room temp. for 10 to 15 min. 2) Stabilize component at room temperature for 1hr. then measure value.	
	Visual	No evidence of mechanical damage			
Low Temperature Storage	$\Delta R/R$	$\pm (2\%+0.1\Omega)$ max. of the initial value	50m $\Omega$ max.	1) Dwell in -55 $^{\circ}$ C chamber without loading for 1000 $^{+8}_{-0}$ hrs. 2) Stabilize component at room temperature for 1hr. then measure value.	
	Visual	No evidence of mechanical damage			
High Temperature Storage	$\Delta R/R$	$\pm (3\%+0.1\Omega)$ max. of the initial value	50m $\Omega$ max.	1) Dwell in 125 $^{\circ}$ C chamber without loading for 1000 $^{+8}_{-0}$ hrs. 2) Stabilize component at room temperature for 1hr. then measure value.	
	Visual	No evidence of mechanical damage			
Moisture Resistance	$\Delta R/R$	$\pm (3\%+0.1\Omega)$ max. of the initial value	50m $\Omega$ max.	1) Dwell in temp.: 65 $^{\circ}$ C RH90 to 95%RH chamber without loading for 1000 $^{+8}_{-0}$ hrs. 2) Stabilize component at room temperature for 1hr. then measure value.	
	Visual	No evidence of mechanical damage			
Life Test	$\Delta R/R$	$\pm (3\%+0.1\Omega)$ max. of the initial value	50m $\Omega$ max.	1) Temp.: 70 $\pm$ 3 $^{\circ}$ C Voltage: (rated voltage) on 90 min. off 30 min. Duration: 1000 $^{+8}_{-0}$ hrs. 2) Stabilize component at room temperature for 1hr. then measure value.	
	Visual	No evidence of mechanical damage			
Loading Life in Moisture	$\Delta R/R$	$\pm (3\%+0.1\Omega)$ max. of the initial value	50m $\Omega$ max.	1) Temp.: 40 $\pm$ 2 $^{\circ}$ C RH: 90 to 95% Voltage Cycle: on 90 min. (rated voltage) off 30 min. Duration: 1000 $^{+8}_{-0}$ hrs. 2) Stabilize component at room temperature for 1hr. then measure value.	
	Visual	No evidence of mechanical damage			

## Tape & Reel

### • Reel

(Unit: mm)

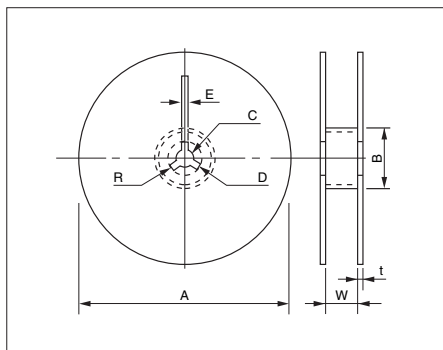

Code	A	B	C	D	E	W	t	R
Width: 8mm	$\phi 178 \pm 2.0$	$\phi 50 \text{ min.}$	$\phi 13.0 \pm 0.5$	$\phi 21.0 \pm 0.8$	$2.0 \pm 0.5$	$10.0 \pm 1.5$	2.5 max.	1.0
Width: 12mm						$13.0 \pm 1.5$		

### • Carrier Tape (8mm)

(Unit: mm)

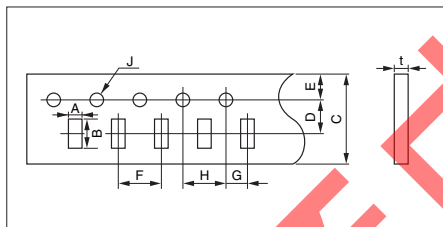

TYPE	Dimension Code	A	B	C	D	E	F	G	H	J	t
0404		$1.2 \pm 0.1$	$1.2 \pm 0.1$				$2.0 \pm 0.1$				0.6 max.
0804		$1.25 \pm 0.2$	$2.25 \pm 0.2$								
0805		$1.65 \pm 0.2$	$2.4 \pm 0.2$	$8.0 \pm 0.2$	$3.5 \pm 0.05$	$1.75 \pm 0.1$	$4.0 \pm 0.1$	$2.0 \pm 0.05$	$4.0 \pm 0.1$	$\phi 1.5 \text{ }^{+0.1}_{-0.1}$	1.1 max.
1206		$2.0 \pm 0.2$	$3.6 \pm 0.2$								

### • Carrier Tape (12mm)

(Unit: mm)

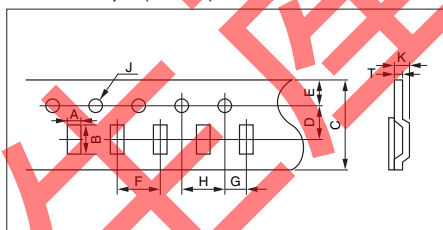

TYPE	Dimension Code	A	B	C	D	E	F	G	H	J	T	K
1020		$2.9 \pm 0.2$	$5.3 \pm 0.2$									
1608		$2.5 \pm 0.2$	$4.4 \pm 0.2$									
2512		$3.5 \pm 0.2$	$6.7 \pm 0.2$	$12.0 \pm 0.3$	$5.5 \pm 0.05$	$1.75 \pm 0.1$	$4.0 \pm 0.1$	$2.0 \pm 0.1$	$4.0 \pm 0.1$	$\phi 1.5 \text{ }^{+0.1}_{-0.1}$	0.6 max.	1.4 max.
2506		$2.0 \pm 0.2$	$6.9 \pm 0.2$									

### • Taping Quantity per reel

(Unit: pcs.)

TYPE	Series	$\phi 178 \text{ reel}$
0404	CRC11A2E, ATC1A	10000 (2mm pitch)
0804	CRB2A4E	10000 (2mm pitch)
0805	LR21	5000 (4mm pitch)
1206	LR32	5000 (4mm pitch)
1020	LR50	4000 (4mm pitch)
1608	RNA4A	4000 (4mm pitch)
2512	LR63	4000 (4mm pitch)
2506	CRB6A8E	4000 (4mm pitch)

Recommended Land Patterns

Chip Type

(Unit: mm)

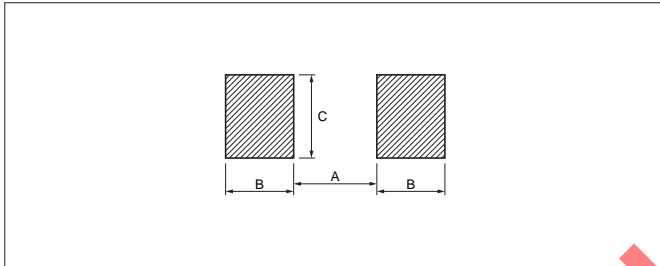

EIA Size	A	B	C
0805	1.0	0.8	1.2
1020	1.4	1.0	5.0
1206	2.2	0.9	1.5
2512	5.0	1.0	3.0

Array Type

(Unit: mm)

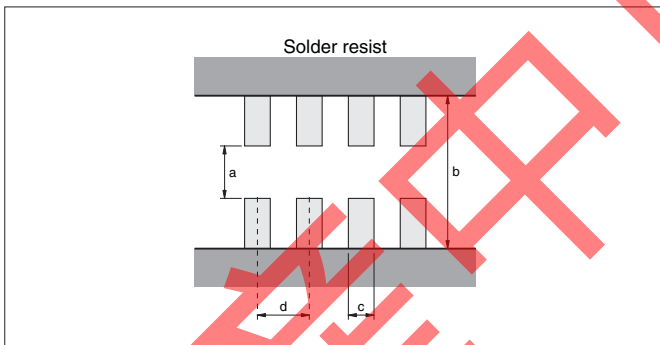

Series	a	b	c	d
CRB2A4E	0.4	1.5	0.25	0.5
CRC11A2E	0.5	1.5	0.4	0.65
CRB6A8E	0.7	2.3	0.4	0.8
ATC1A	0.5	1.5	0.4	0.65

(Unit: mm)

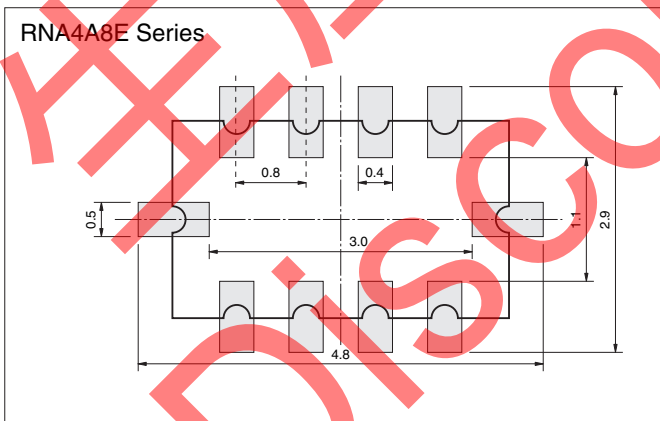

**Circuit design**

- 1) Once application and assembly environments have been checked, the resistors may be used in conformance with the catalog and the specifications.
- 2) Please consult the manufacturer in advance when the resistors is used in devices such as: devices which deal with human life, i.e. medical devices; devices which are highly public orientated; and devices which demand a high standard of liability.
- 3) Please use the resistors in conformance with the operating temperature provided in both the catalog and the specifications.
- 4) Please keep voltage under the rated voltage which is applied to the resistor.
- 5) Do not use the resistor in an environment where it might easily exceed the respective provisions concerning shock and vibration specified in the catalog and specifications.
- 6) Please do not use the resistor in the following environments.
  - ① State that water, oil, and solvent hang in resistor
  - ② State where poisonous gas (sulfur and chlorine, etc.) exists
  - ③ State that direct sunshine, radiation, and ultraviolet, etc. are irradiated
- 7) There is a thing that resistance changes according to the stuff of the resin when the coating with the resin is given. Please use resin coating after confirming the characteristic.
- 8) There is a thing that resistance changes according to flux and cleaner. Please use flux and cleaner after confirming the characteristic.
- 9) Please consult about a lead free products.

**Storage**

- 1) Keep storage place temperature +5 to +35°C, humidity 45 to 75% RH.
- 2) Please keep parts out of poisonous gas such as sulfur or chlorine in the air and out of salty moisture, or they may cause rust of terminal and poor solderability. Please consider the above-mentioned item after mounting.
- 3) Soldering iron

<b>Temperature</b>	soldering iron 300±5°C *
<b>Time</b>	3 sec. max. *

\*Do not place the soldering iron on the chip. Soldering iron is 30W max.

**Soldering method**

1) Recommendable temperature profile

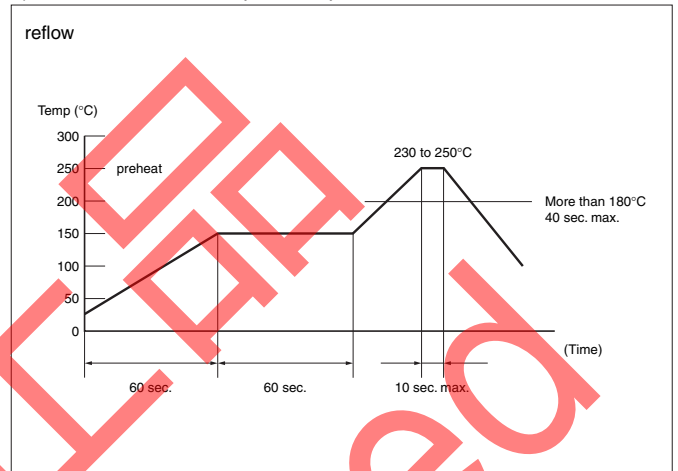

2) Recommendable temperature profile

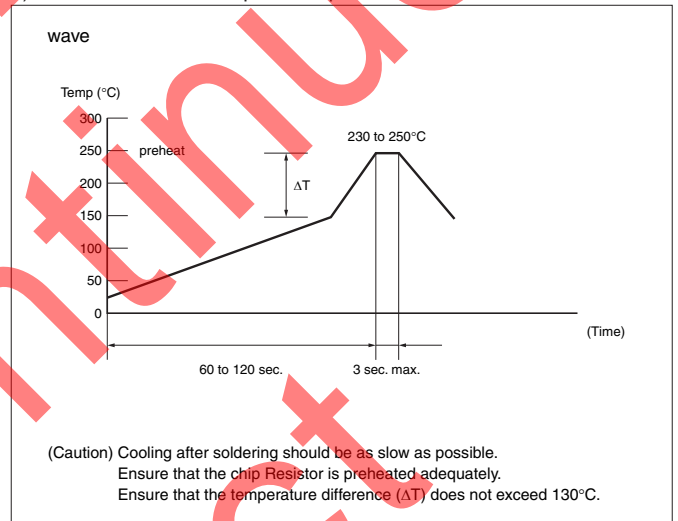

3) Pb-free recommendable temperature profile

