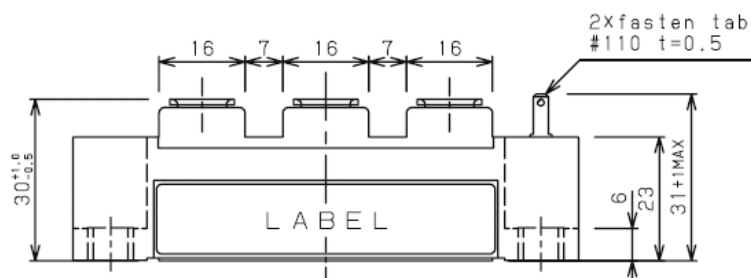
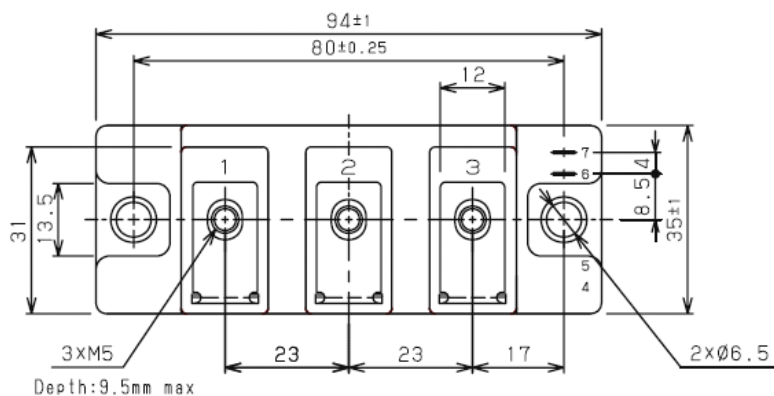
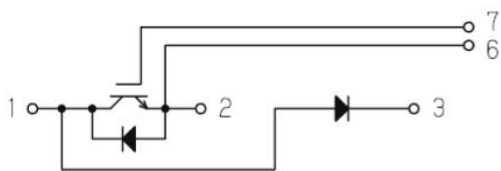

□ 回路図 : *CIRCUIT*

 □ 概略図 : *SCHEMATIC DIAGRAM*

Dimension: [mm]

 □ 最大定格 : *MAXIMUM RATINGS* (at  $T_c=25^\circ\text{C}$  unless otherwise specified)

Item		Symbol	Condition	Rated Value	Unit
IGBT	コレクタ・エミッタ間電圧 Collector-Emitter Voltage	$V_{CES}$	G-E Short	1200	V
	ゲート・エミッタ間電圧 Gate-Emitter Voltage	$V_{GES}$	C-E Short	$\pm 20$	V
	コレクタ電流 Collector Current	$I_C$	DC $T_c=85^\circ\text{C}$	100	A
		$I_{CP}$	Pulse $\leq 1\text{ms}$	200	
コレクタ損失 Collector Power Dissipation	$P_C$	$T_j=175^\circ\text{C}$	483	W	
		$T_j=150^\circ\text{C}$	403		
FWD	繰り返しピーク逆電圧 Repetitive peak reverse voltage	$V_{RRM}$		1200	V
	順電流 Forward Current	$I_F$		100	A
		$I_{FM}$	Pulse $\leq 1\text{ms}$	200	
最大接合温度 Maximum Junction Temperature		$T_{jMAX}$	瞬時動作(過負荷) Instantaneous Overload	175	$^\circ\text{C}$
接合温度範囲 Junction Temperature Range		$T_j$		$-40 \sim +150$	$^\circ\text{C}$
保存温度範囲 Storage Temperature Range		$T_{stg}$		$-40 \sim +125$	$^\circ\text{C}$
絶縁耐圧 Isolation Voltage		$V_{ISO}$	Terminal to Base AC, 1minute	2,500	V (RMS)
締め付けトルク Mounting Torque	Module Base to Heatsink	$F_{tor}$	M6	3	N · m
	Busbar to Main Terminal		M5	2	

□ 電 氣 的 特 性 : **ELECTRICAL CHARACTERISTICS** (at  $T_J=25^\circ\text{C}$  unless otherwise specified)

Characteristic		Symbol	Test Condition	Min.	Typ.	Max.	Unit	
IGBT	コレクタ遮断電流 Collector-Emitter Cut-Off Current	$I_{CES}$	$V_{CE}=1200V, V_{GE}=0V$	—	—	1.0	mA	
	ゲート漏れ電流 Gate-Emitter Leakage Current	$I_{GES}$	$V_{GE}=\pm 20V, V_{CE}=0V$	—	—	1.0	$\mu\text{A}$	
	コレクタ・エミッタ間飽和電圧 Collector-Emitter Saturation Voltage	$V_{CE(sat.)}$	$I_C=100A, V_{GE}=15V$ (chip level)	$T_J=25^\circ\text{C}$ $T_J=125^\circ\text{C}$ $T_J=150^\circ\text{C}$	— — —	1.50 1.70 1.80	2.00 — —	V
	ゲートしきい値電圧 Gate-Emitter Threshold Voltage	$V_{GE(th.)}$	$V_{CE}=10V, I_C=3.3mA$		4.8	—	7.0	V
	入力容量 Input Capacitance	$C_{ies}$	$V_{CE}=25V, V_{GE}=0V, f=1MHz$		—	10.0	—	nF
	出力容量 Output Capacitance	$C_{oes}$			—	0.30	—	
	帰還容量 Reverse Transfer Capacitance	$C_{res}$			—	0.23	—	
	ゲート電荷量 Gate Charge	$Q_g$	$V_{CC}=600V, I_C=100A, V_{GE}=-15\sim+15V$		—	1100	—	nC
	スイッチング時間 Switching Time	上昇時間 Rise Time	$t_r$	$V_{CC}=600V, L_s=38nH$ $I_C=100A$ $R_G=75\Omega$ $V_{GE}=\pm 15V$ $T_J=150^\circ\text{C}$ Inductive Load	—	60	—	ns
		ターンオン遅延時間 Turn-on Delay Time	$t_d(on)$		—	110	—	
下降時間 Fall Time		$t_f$	—		190	—		
ターンオフ遅延時間 Turn-off Delay Time		$t_d(off)$	—		500	—		
FWD	順電圧 Peak Forward Voltage	$V_F$	$I_F=100A, V_{GE}=0V$ (chip level)	$T_J=25^\circ\text{C}$ $T_J=125^\circ\text{C}$ $T_J=150^\circ\text{C}$	— — —	2.00 1.98 1.95	2.60 — —	V
	逆回復時間 Reverse Recovery Time	$t_{rr}$	$V_{CC}=600V, L_s=38nH$ $I_C=100A$ $R_G=75\Omega$ $V_{GE}=\pm 15V$ $T_J=150^\circ\text{C}$ Inductive Load		—	170	—	ns
内部配線抵抗 Internal Lead Resistance		$R_{CC+EE}$	主端子—チップ間 / 1素子 Main Terminal - Chip / Per 1 Arm		—	—	1	m $\Omega$
内部インダクタンス Stray Inductance		$L_{SCE}$	メイン端子3—2間 Main Terminal 3 - Main Terminal 2		—	30	—	nH

 □ 熱 的 特 性 : **THERMAL CHARACTERISTICS**

Characteristic		Symbol	Test Condition	Min.	Typ.	Max.	Unit
熱 抵 抗 Thermal Resistance	IGBT	$R_{th(j-c)}$	Junction to Case Per 1 Arm (T <sub>c</sub> 測定点:チップ直下)	—	—	0.31	°C/W
	FWD			—	—	0.72	
接 触 熱 抵 抗 Thermal Resistance	IGBT	$R_{th(c-f)}$	Case to heatsink Per 1 Arm Paste=1W/(m <sup>2</sup> °C)	—	0.10	—	
	FWD			—	0.17	—	

特性图 : CHARACTERISTICS CURVES

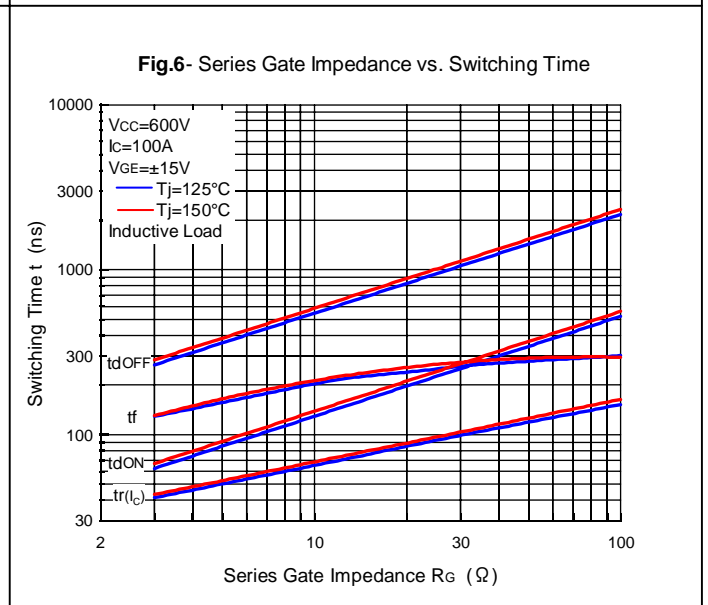
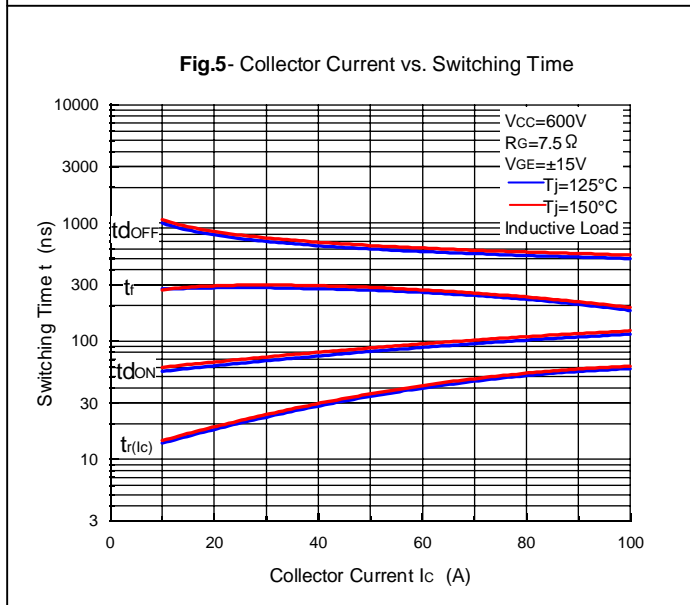
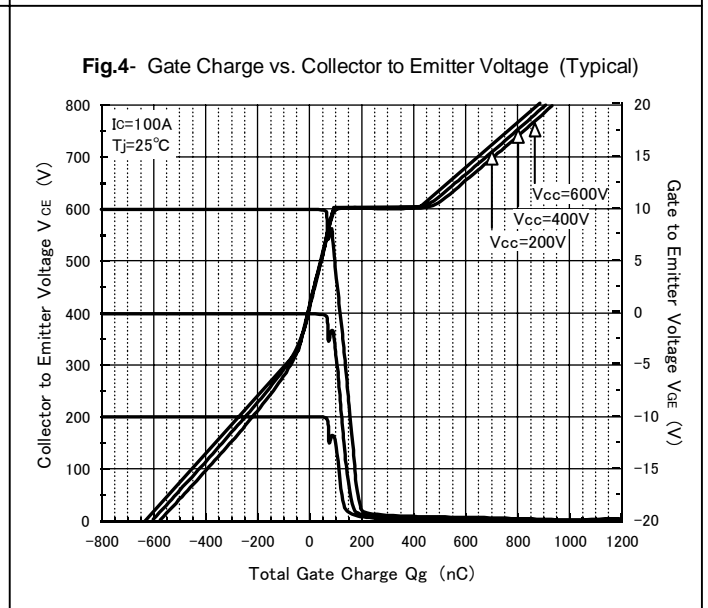
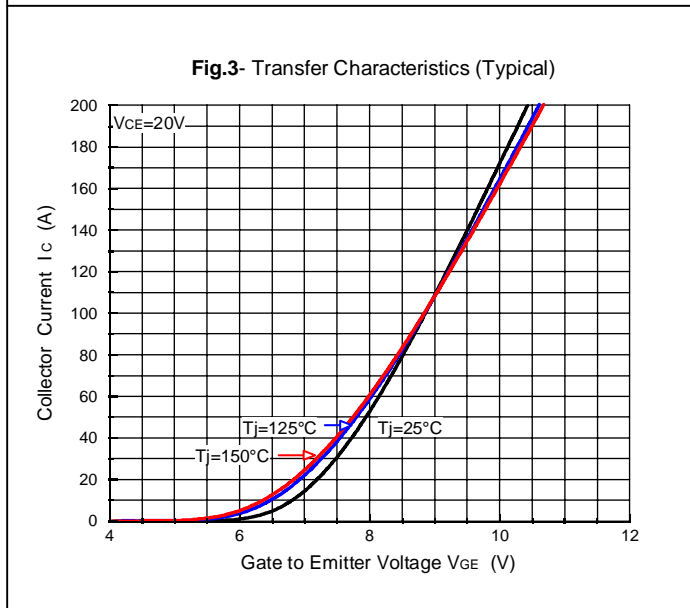
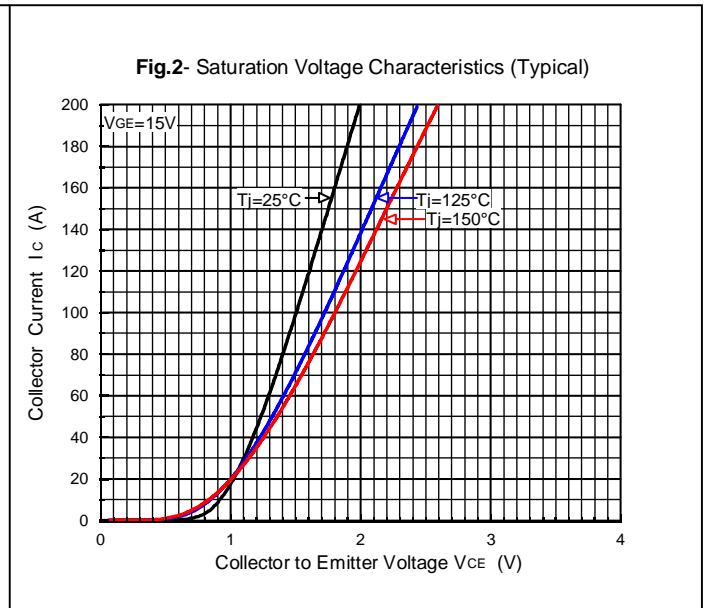
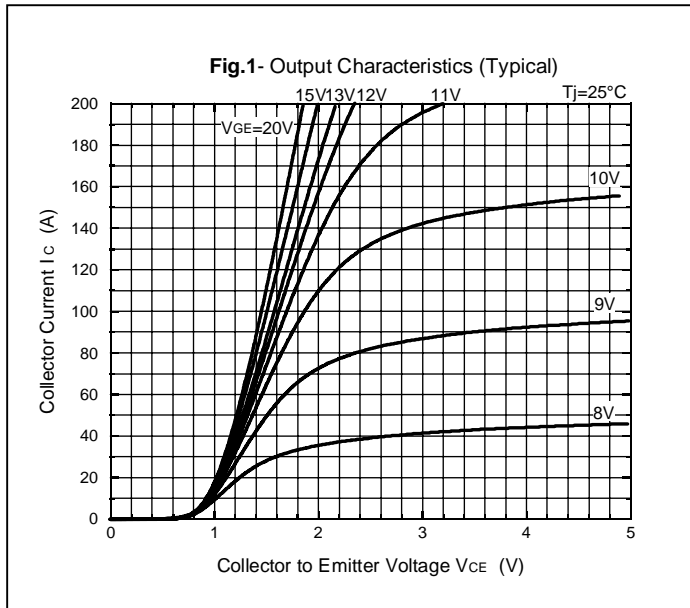

特图 : CHARACTERISTICS CURVES

