



Diode Module

K34DD400P080AAA

特徴

Feature

- RoHS 指令準拠
RoHS Compliant

用途

Application

- 一般整流用
For General Use



外形図

Outline Drawing

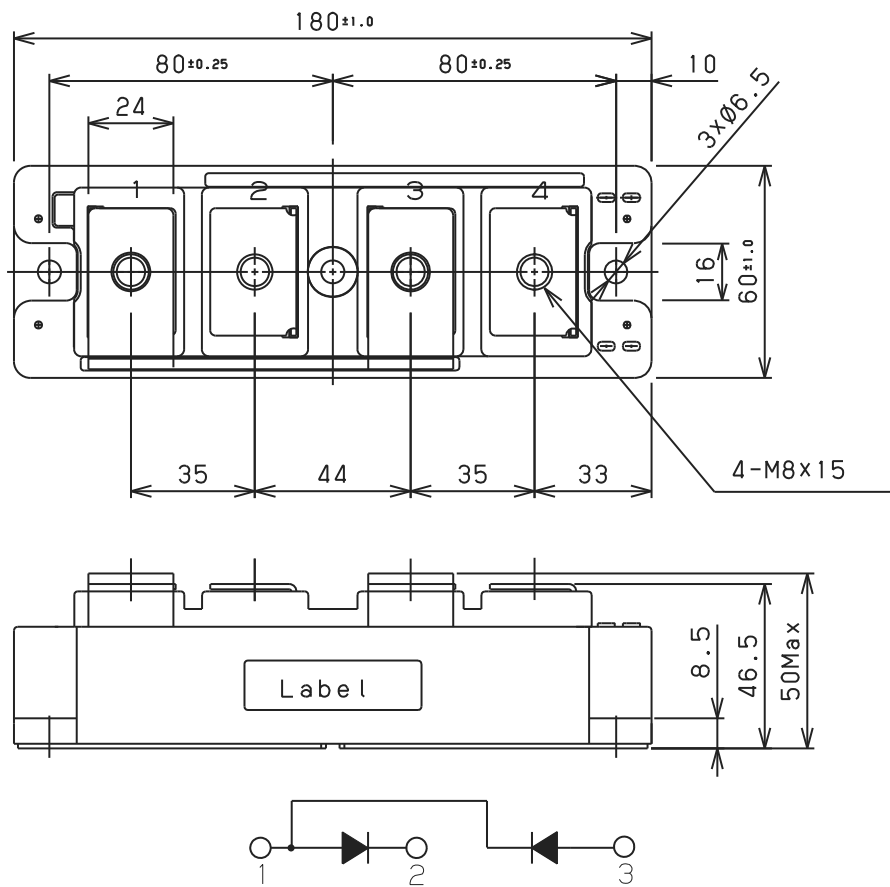

回路構成 Circuit Schema

【単位：mm】

最大定格 Maximum Ratings

項目 Parameter	記号 Symbol	耐圧クラス Grade		単位 Unit
		K34DD400P080AAA		
くり返しピーク逆電圧 *1 Repetitive Peak Reverse Voltage	V_{RRM}	800		V
非くり返しピーク逆電圧 *1 Non Repetitive Peak Reverse Voltage	V_{RSM}	900		V

項目 Parameter	記号 Symbol	条件 Conditions	定格値 Max. Rated Value	単位 Unit		
平均整流電流 *1 Average Rectified Output Current	$I_{O(AV)}$	商用周波数 180° 通電 $T_c=125^{\circ}C$ Half Sine Wave	400	A		
実効順電流 *1 RMS Forward Current	$I_{F(RMS)}$		630	A		
サージ順電流 *1 Surge Forward Current	I_{FSM}	50Hz 正弦半波, 1 サイクル, 非くり返し Half Sine Wave, 1Pulse, Non-Repetitive	8000	A		
電流二乗時間積 *1 I Squared t	I^2t	2~10ms	320000	$A^2 s$		
動作接合温度範囲 Operating Junction Temperature Range	T_{jw}		-40 ~ +150	$^{\circ}C$		
保存温度範囲 Storage Temperature Range	T_{stg}		-40 ~ +125	$^{\circ}C$		
絶縁耐圧 Isolation Voltage	V_{iso}	端子-ベース間, AC 1 分間 Terminal to Base, AC 1min.	2500	V		
締付トルク Mounting Torque	ベース部 Base	F	サーマルコンパウンド塗布 Greased	M6	2.5 ~ 3.5	$N \cdot m$
	主端子部 Terminal			M8	9.0 ~ 10.0	$N \cdot m$

電気的特性 Electrical Characteristics

項目 Parameter	記号 Symbol	条件 Conditions	特性値 (最大) Maximum Value	単位 Unit	
ピーク逆電流 *1 Peak Reverse Current	I_{RM}	$T_j=150^{\circ}C$, $V_{RM}=V_{RRM}$	15	mA	
ピーク順電圧 *1 Peak Forward Voltage	V_{FM}	$T_j=25^{\circ}C$, $I_{FM}=1300A$	Terminal	1.33	V
			Chip	1.13	
	$V_{(FO)}$ *2	$T_j=150^{\circ}C$	0.74	V	
	r_f *2	$T_j=150^{\circ}C$	0.24	$m\Omega$	
熱抵抗 *1 Thermal Resistance	$R_{th(j-c)}$	接合部-ケース間(T_c 測定点: チップ直下) Junction to Case	0.05	$^{\circ}C/W$	
接触熱抵抗 *1 Thermal Resistance	$R_{th(c-f)}$	ケース-フィン間, サーマルコンパウンド塗布 Case to Fin, Greased	0.05	$^{\circ}C/W$	

質量 --- 約 1000g Approximate Weight

*1 : 1 アーム当りの値 Value Per 1 Arm. *2 : $V_F \div V_{(FO)} + I_F \times r_f$ For power-loss calculation only

順電圧特性
FORWARD CURRENT VS. VOLTAGE

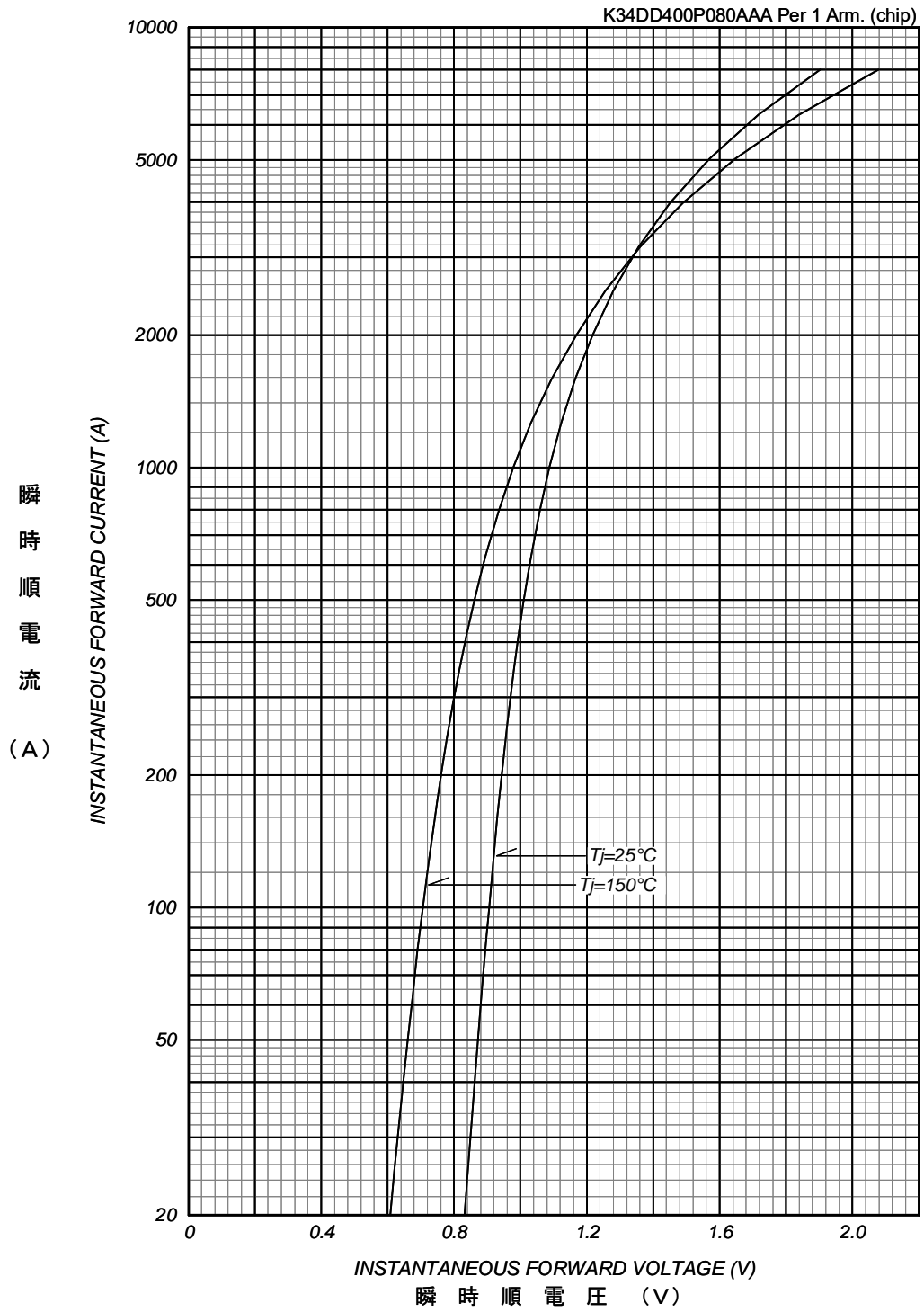

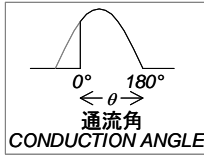

平均順電力損失特性
AVERAGE FORWARD POWER DISSIPATION

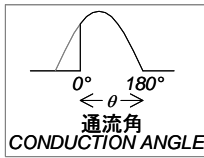
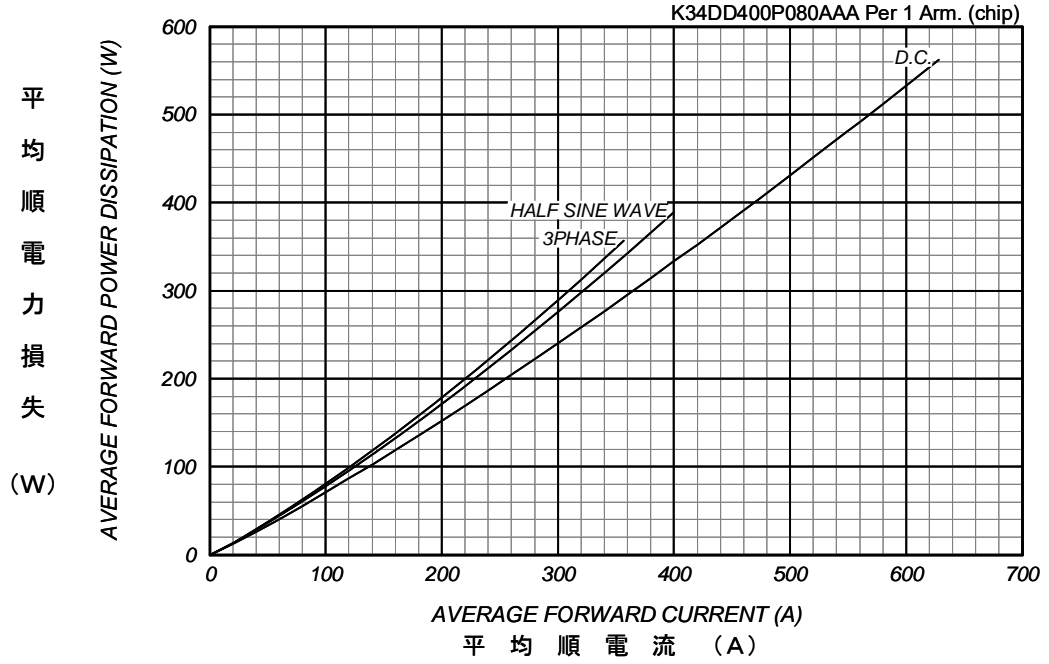

平均順電流 - ケース温度定格
AVERAGE FORWARD CURRENT VS. CASE TEMPERATURE

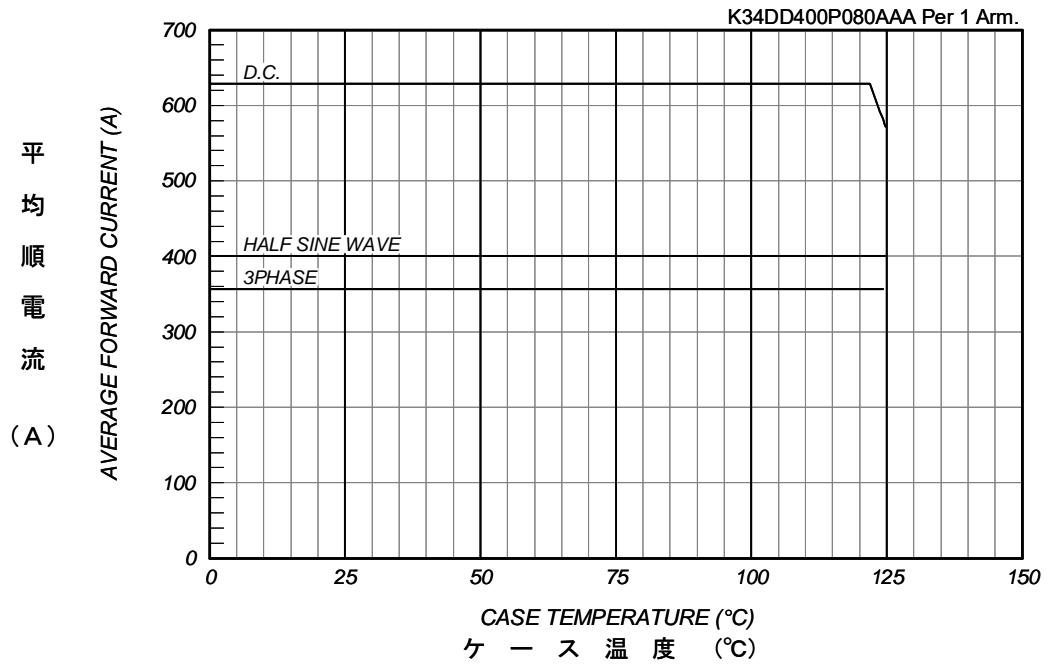

サージ順電流定格
SURGE CURRENT RATINGS

f=50Hz, Half Sine Wave, Non-Repetitive, Tj=150°C

K34DD400P080AAA Per 1 Arm.

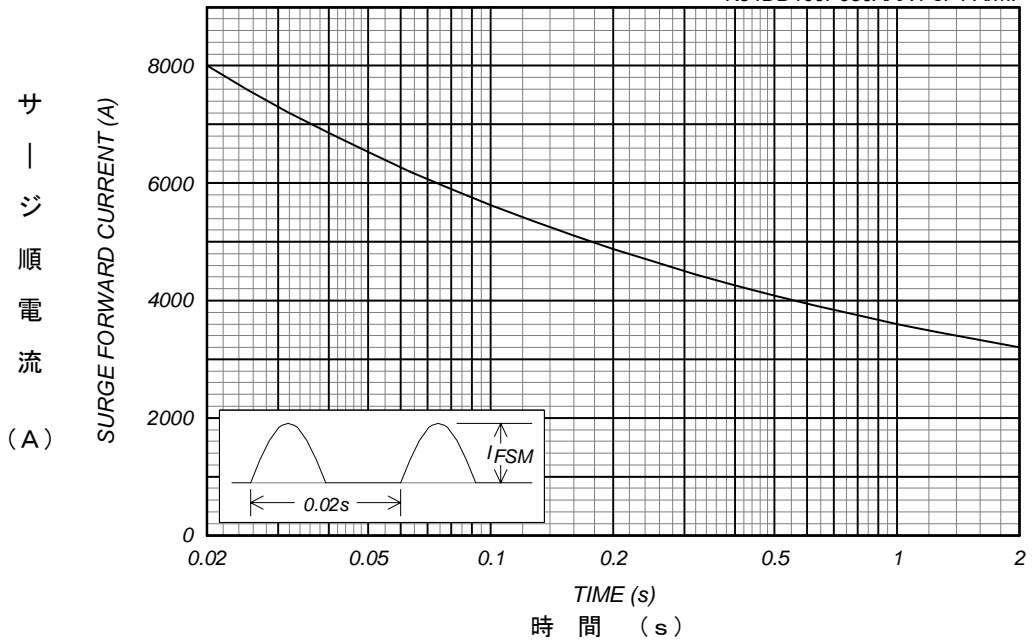

過渡熱抵抗特性
Transient Thermal Impedance

K34DD400P080AAA Per 1 Arm.

