

Diode Module

K02DF100N080AAA

特徴

Feature

- RoHS 指令準拠
RoHS Compliant

用途

Application

- 一般整流用
For General Use



外形図

Outline Drawing

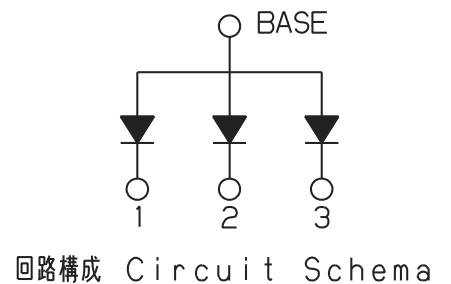
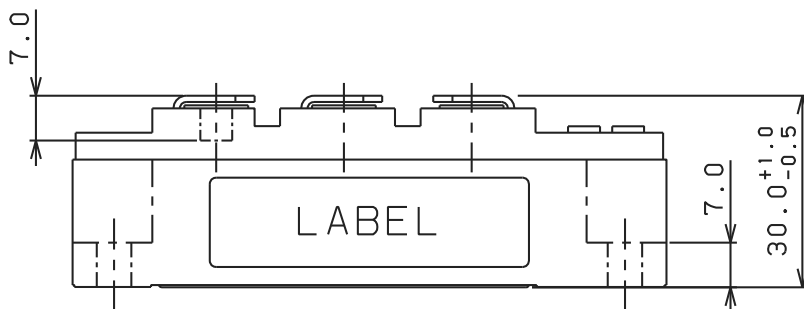
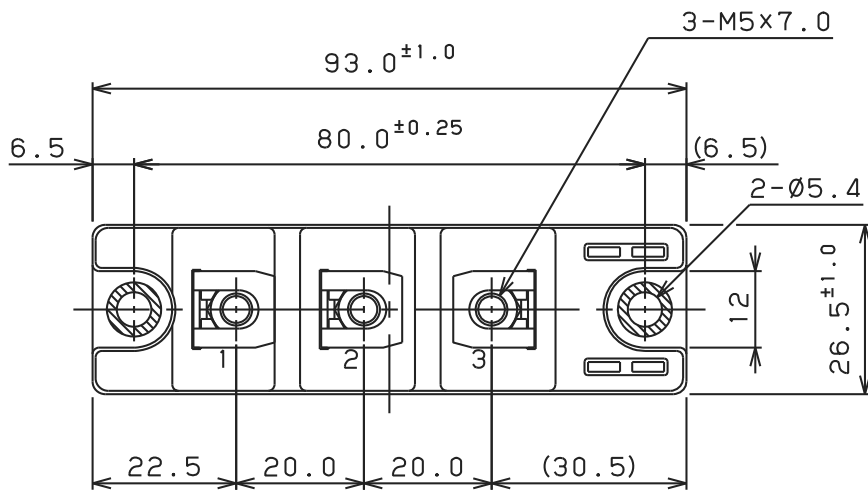

【単位：mm】

最大定格 Maximum Ratings

項目 Parameter	記号 Symbol	耐圧クラス Grade		単位 Unit
		K02DF100N080AAA		
くり返しピーク逆電圧 *1 Repetitive Peak Reverse Voltage	V _{RRM}	800		V
非くり返しピーク逆電圧 *1 Non Repetitive Peak Reverse Voltage	V _{RSM}	900		V

項目 Parameter	記号 Symbol	条件 Conditions	定格値 Max. Rated Value	単位 Unit	
平均整流電流 *1 Average Rectified Output Current	I _{o (AV)}	商用周波数 180° 通電 Tc=125°C Half Sine Wave	100	A	
		3-Phase 120° 通電 Tc=110°C	88	A	
サージ順電流 *1 Surge Forward Current	I _{FSM}	50Hz 正弦半波, 1 サイクル, 非くり返し Half Sine Wave, 1Pulse, Non-Repetitive	2000	A	
電流二乗時間積 *1 I Squared t	I ² t	2~10ms	20000	A ² s	
動作接合温度範囲 Operating Junction Temperature Range	T _{jw}		-40 ~ +150	°C	
保存温度範囲 Storage Temperature Range	T _{stg}		-40 ~ +125	°C	
締付トルク Mounting Torque	ベース部 Base	サーマルコンパウンド塗布 Greased	M5	2.4 ~ 2.8	N・m
	主端子部 Terminal		M5	2.4 ~ 2.8	N・m

電気的特性 Electrical Characteristics

項目 Parameter	記号 Symbol	条件 Conditions	特性値 (最大) Maximum Value	単位 Unit
ピーク逆電流 *1 Peak Reverse Current	I _{RM}	T _j =150°C, V _{RM} =V _{RRM}	5	mA
ピーク順電圧 *1 Peak Forward Voltage	V _{FM}	T _j = 25°C, I _{FM} = 320A	1.25	V
	V _(FO) *2	T _j =150°C	0.76	V
	r _f *2	T _j =150°C	1.73	mΩ
熱抵抗 *1 Thermal Resistance	R _{th(j-c)}	接合部-ケース間(Tc 測定点: チップ直下) Junction to Case	0.2	°C/W
接触熱抵抗 *1 Thermal Resistance	R _{th(c-f)}	ケース-フィン間, サーマルコンパウンド塗布 Case to Fin, Greased	0.2	°C/W

質量 --- 約 105g Approximate Weight

*1 : 1 アーム当りの値 Value Per 1 Arm. *2 : $V_F \doteq V_{(FO)} + I_F \times r_f$ For power-loss calculation only

順電圧特性
FORWARD CURRENT VS. VOLTAGE

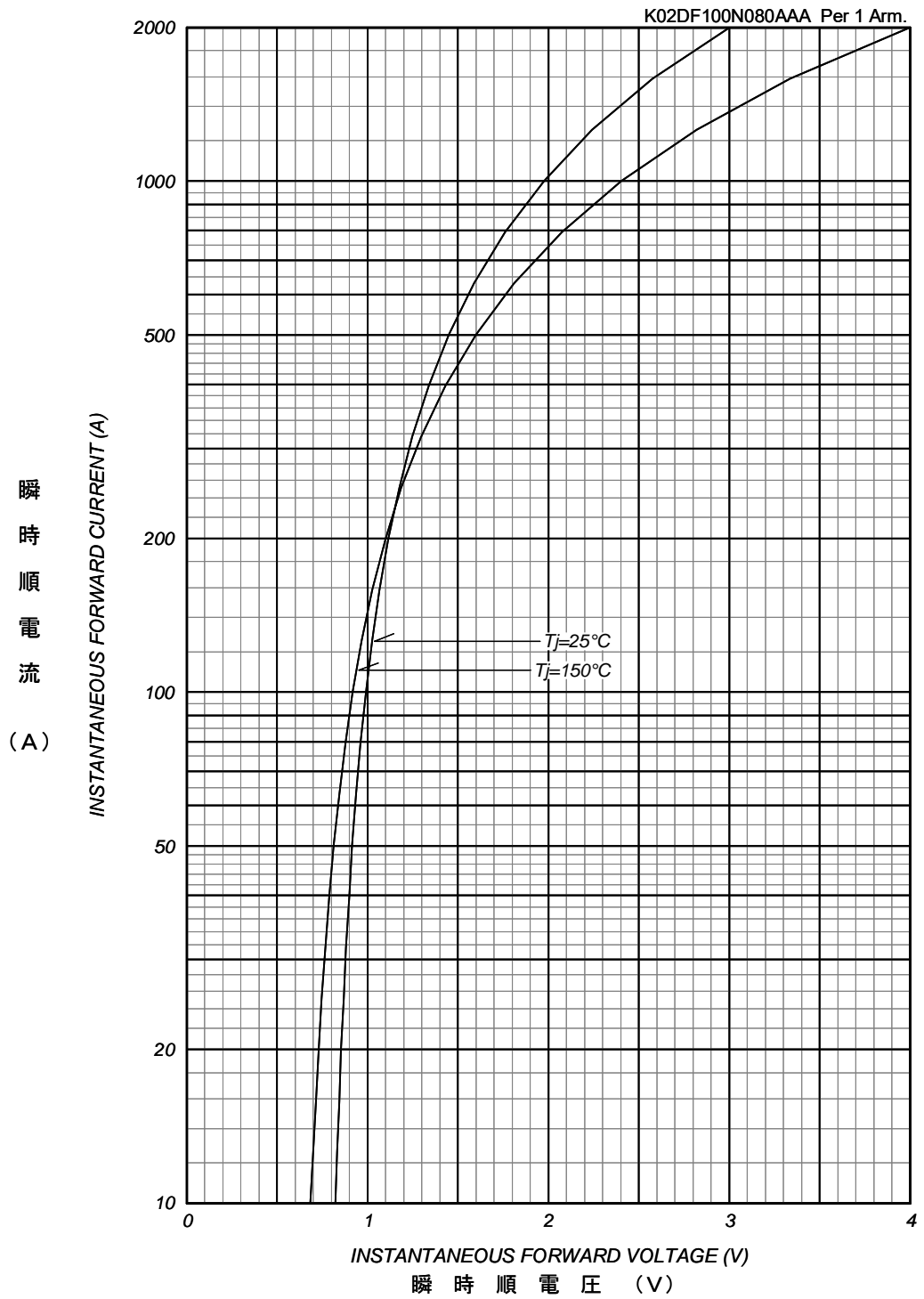

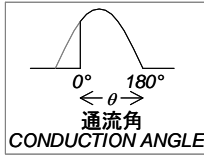

平均順電力損失特性
AVERAGE FORWARD POWER DISSIPATION

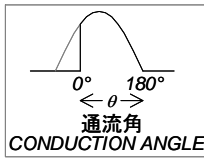
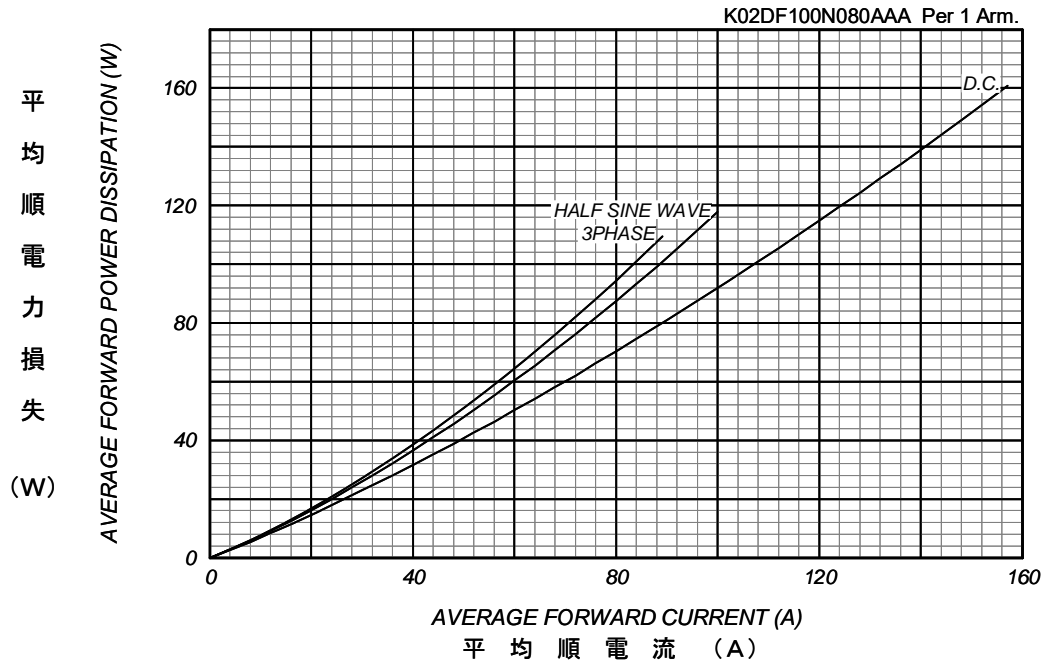

平均順電流 - ケース温度定格
AVERAGE FORWARD CURRENT VS. CASE TEMPERATURE

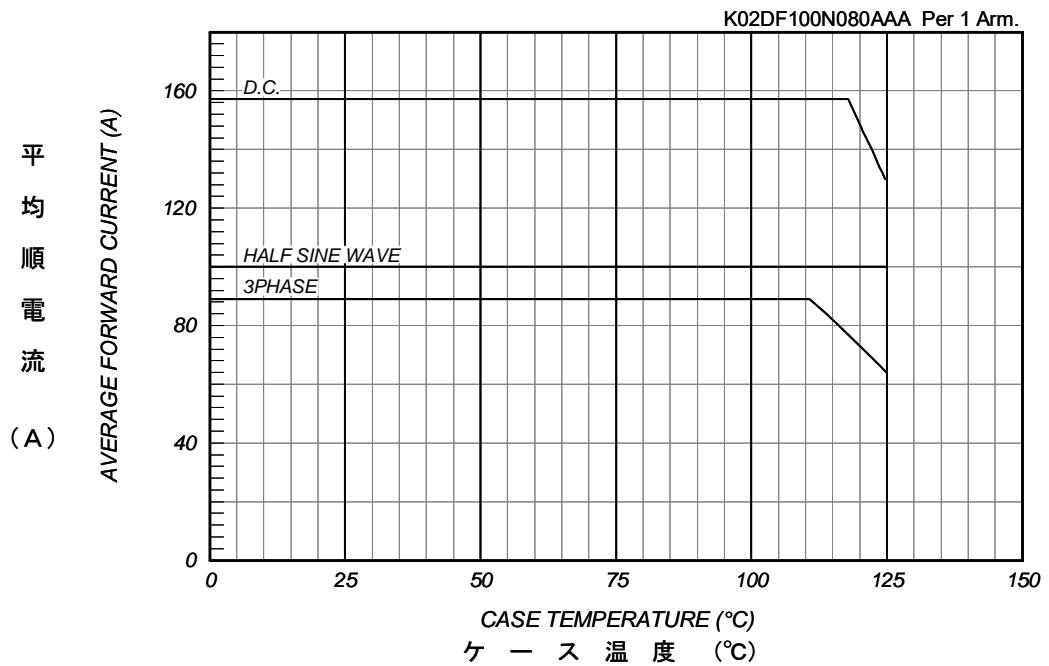

サージ順電流定格
SURGE CURRENT RATINGS

f=50Hz, Half Sine Wave, Non-Repetitive, Tj=150°C

K02DF100N080AAA Per 1 Arm.

サ
ー
ジ
順
電
流

(A)

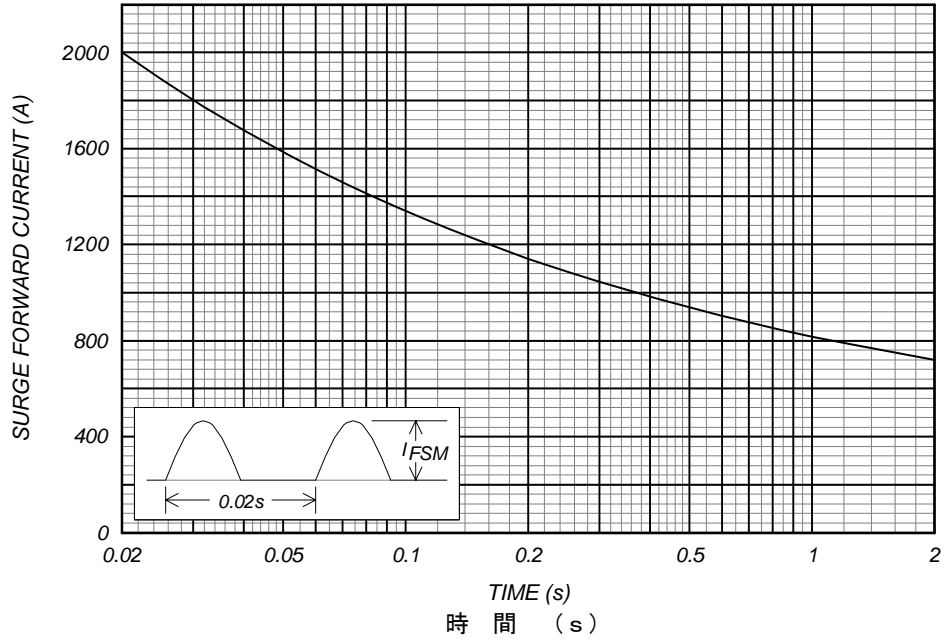

過渡熱抵抗特性
Transient Thermal Impedance

K02DF100N080AAA Per 1 Arm.

過
渡
熱
抵
抗

(°C/W)

