

ダイオード製品仕様書

DIODE DATA SHEET

仕様書No.QMS7301-302-A0089 (1/5)

I1748PJA250

最大定格 Maximum Ratings

項目 Item	記号 symbol	条件 Condition	定格 Rating	Unit
くり返しピーク逆電圧 Repetitive peak reverse voltage	V_{RRM}		2500	V
非くり返しピーク逆電圧 Non-repetitive peak reverse voltage	V_{RSM}		2600	V
平均順電流 Average forward current	$I_{O(AV)}$	50Hz Half sine wave, 180° 通電 $T_f=65^{\circ}\text{C}$	1300	A
実効順電流 RMS forward current	$I_{F(RMS)}$		2042	A
非繰り返しサーージ順電流 Non-repetitive Surge forward current	I_{FSM}	50Hz Half sine wave, 1cycle, $V_R=0\text{V}$ $T_j(\text{initial})=160^{\circ}\text{C}$	13300	A
電流二乗時間積 I ² t capacity	I^2t	2~10ms	8.84×10^5	A ² s
動作接合温度範囲 Operating junction temperature range	T_{jw}		-40~+160	°C
保存温度範囲 Storage temperature range	T_{stg}		-40~+160	°C
圧接力 Mounting force	F	()内は推奨値 () Recommended Value	20 (15)	kN

電気的特性 (指定なき場合は $T_j=25^{\circ}\text{C}$) Electric Characteristics ($T_j=25^{\circ}\text{C}$:Unless otherwise specified)

項目 Item	記号 Symbol	条件 Condition	Min.	Typ.	Max.	Unit
ピーク順電圧 Peak forward voltage	V_{FM}	$T_j=25^{\circ}\text{C}$, $I_{FM}=4000\text{A}$	-	-	2.15	V
しきい値電圧 Threshold voltage	V_{TO}	$I_{F(AV)} \sim \pi \cdot I_{F(AV)}$, $T_j=160^{\circ}\text{C}$	-	-	1.09	V
微分抵抗 Slope resistance	r_t	$I_{F(AV)} \sim \pi \cdot I_{F(AV)}$, $T_j=160^{\circ}\text{C}$	-	-	0.30	mΩ
ピーク逆電流 Peak reverse current	I_{RRM}	$T_j=160^{\circ}\text{C}$, $V_R=V_{RRM}$	-	-	30	mA

熱特性 Thermal Characteristics

項目 Item	記号 Symbol	条件 Condition	Min.	Typ.	Max.	Unit
熱抵抗 (接合部-フィン間) Thermal resistance junction to Fin	$R_{th(j-f)}$	Double side cooled, With greased	-	-	0.033	°C/W

重量 Weight

項目 Item	記号 Symbol	条件 Condition	Min.	Typ.	Max.	Unit
重量 Weight	W_t		-	190	-	g

* 本製品は一般的な電子機器に使用されることを意図しております。極めて高度な信頼性が要求され、その製品の故障や誤動作が直接人命に関わるような機器・装置へのご使用を検討される際は、事前に弊社営業窓口までご相談願います。

* 当仕様書は事前の通知なく改正される事があります。正式採用時には承認図をご請求の上、仕様の確認をして下さい。

Descriptions in this specification are subject to change without announcement.

This product should not be used in any applications requiring extremely higher reliability, where a failure of the product or any consequences of the use of there of can reasonably be expected to result in personal injury or fatal accident, without any prior approval by Kyocera.

順電圧特性 FORWARD CURRENT VS. VOLTAGE

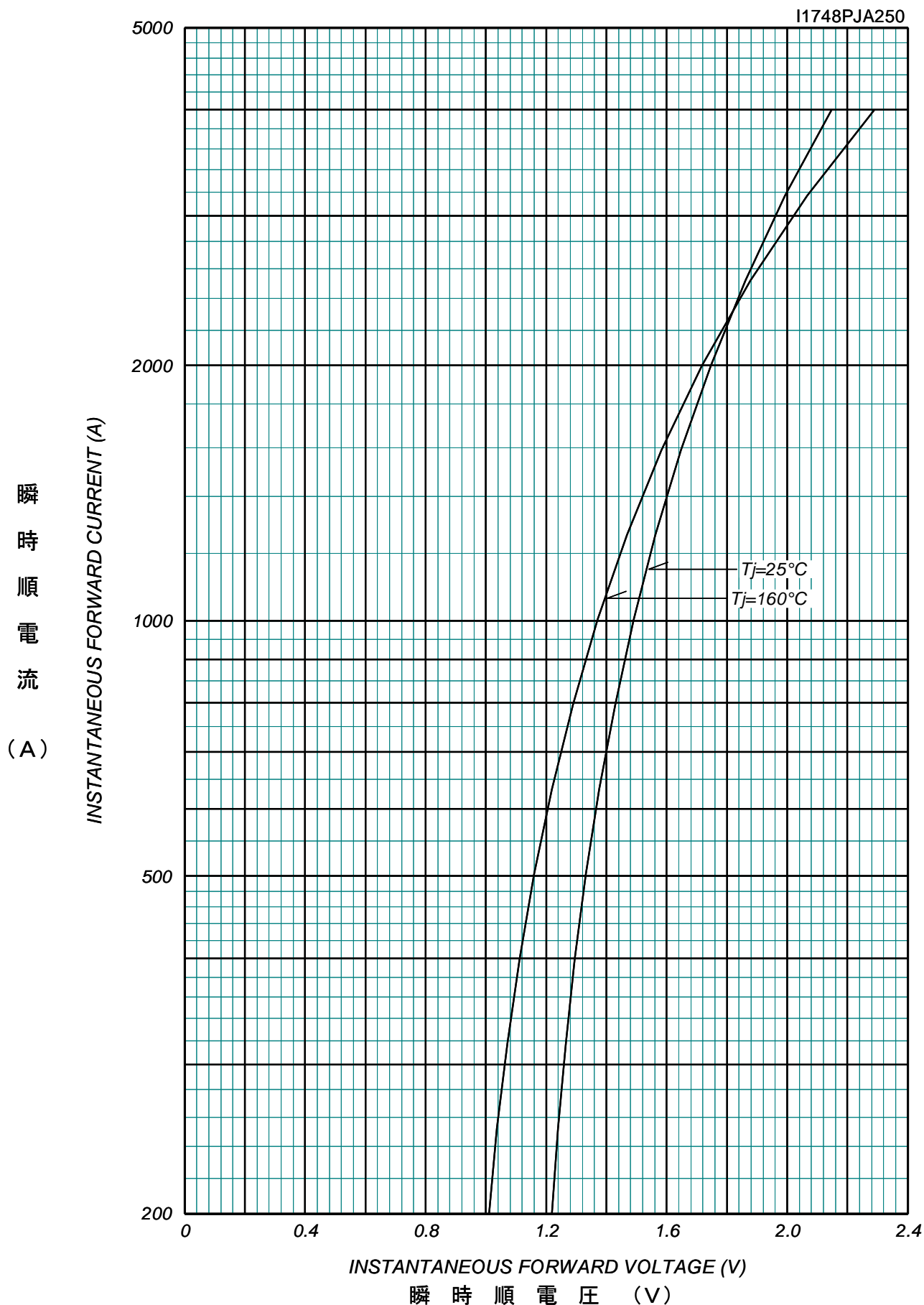

平均順電力損失特性

AVERAGE FORWARD POWER DISSIPATION

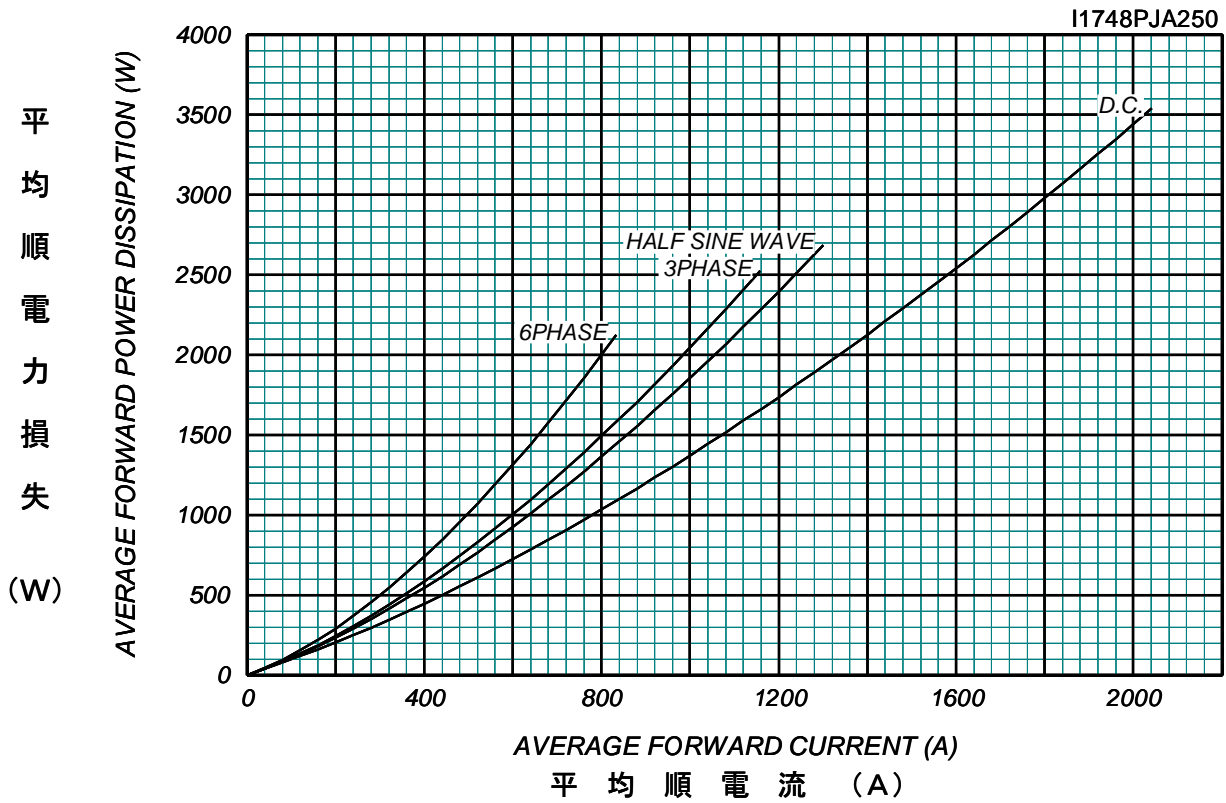

平均順電流 - フィン温度定格

AVERAGE FORWARD CURRENT VS. FIN TEMPERATURE

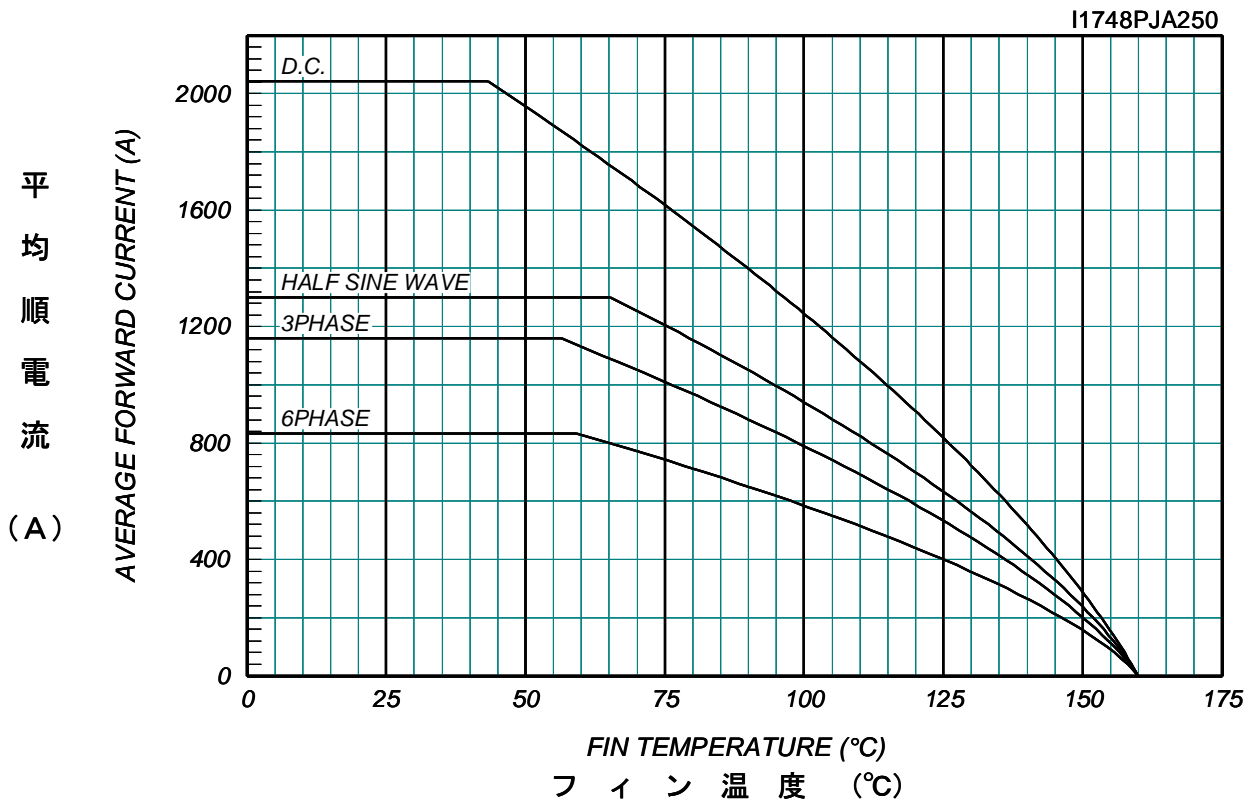

サージ順電流定格

SURGE CURRENT RATINGS

f=50Hz, Half Sine Wave, Non-Repetitive, On Load

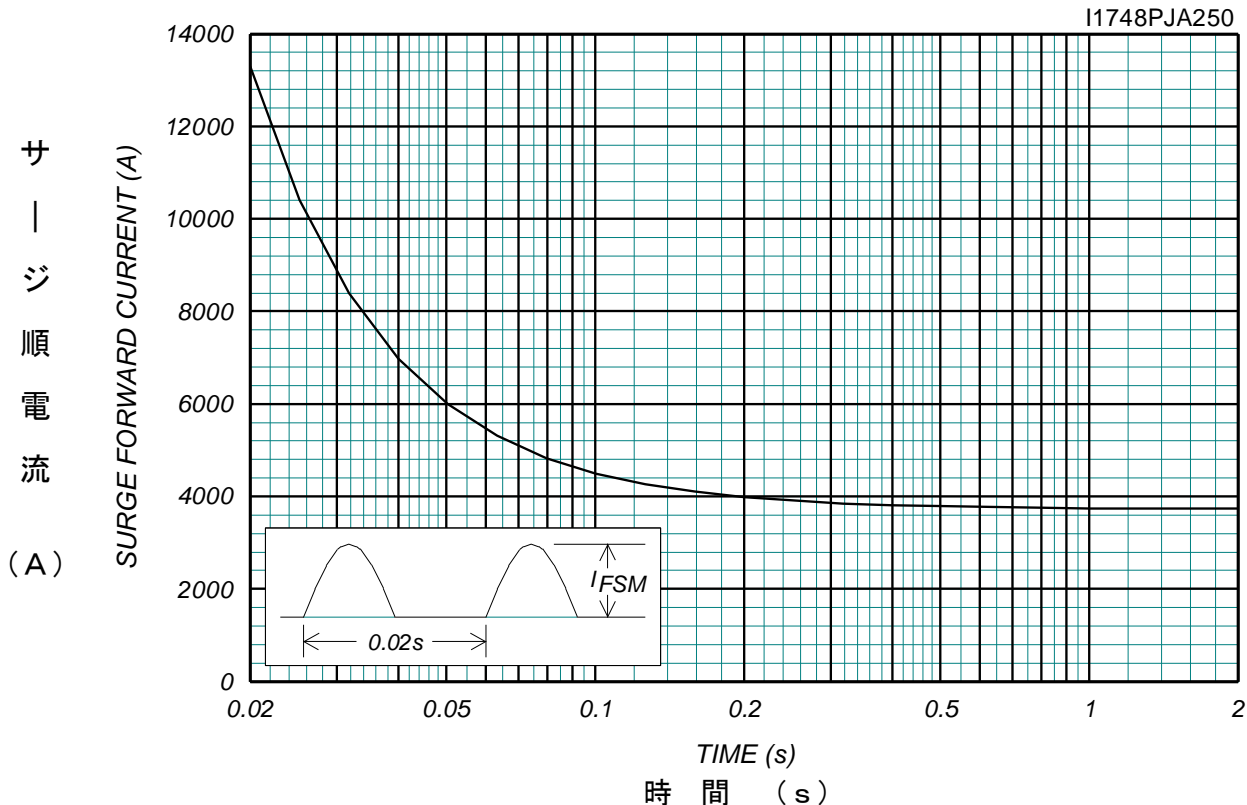

過渡熱抵抗特性

Transient Thermal Impedance

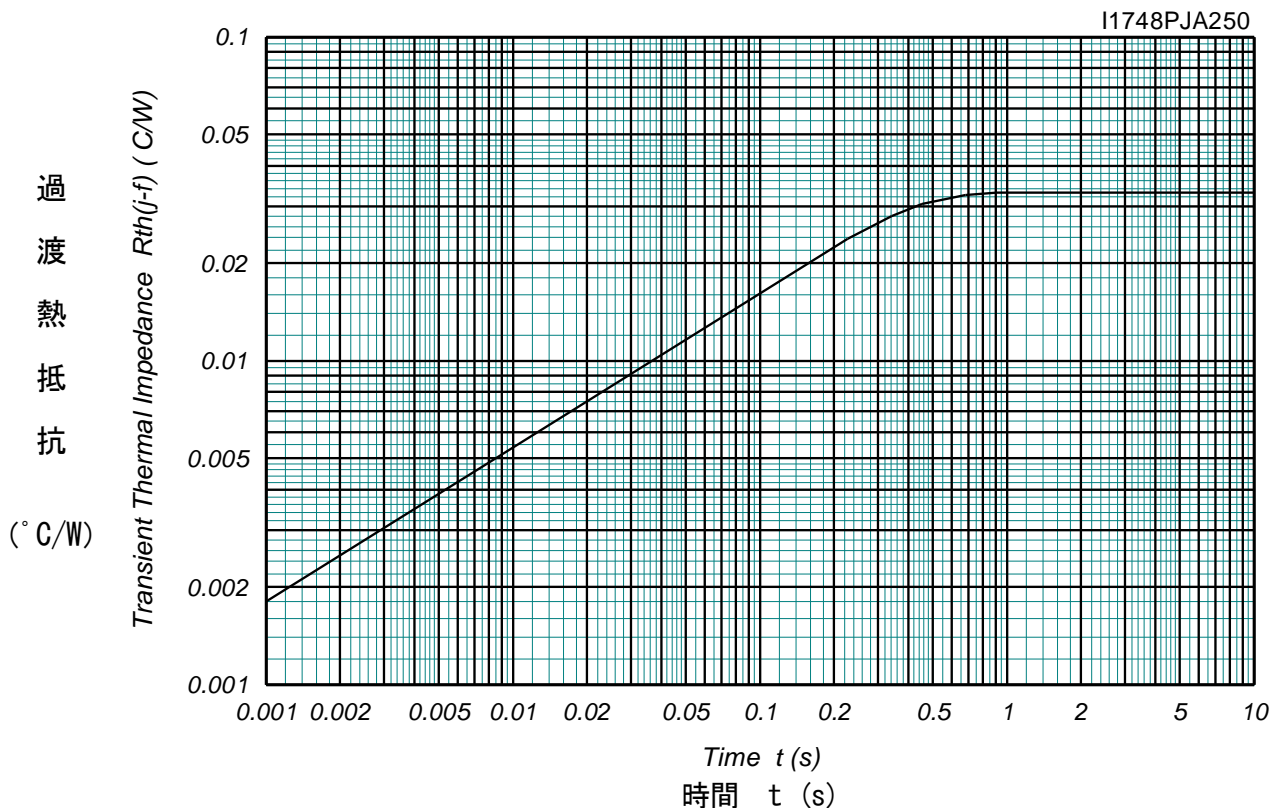

逆回復特性

Reverse Recovery Characteristics

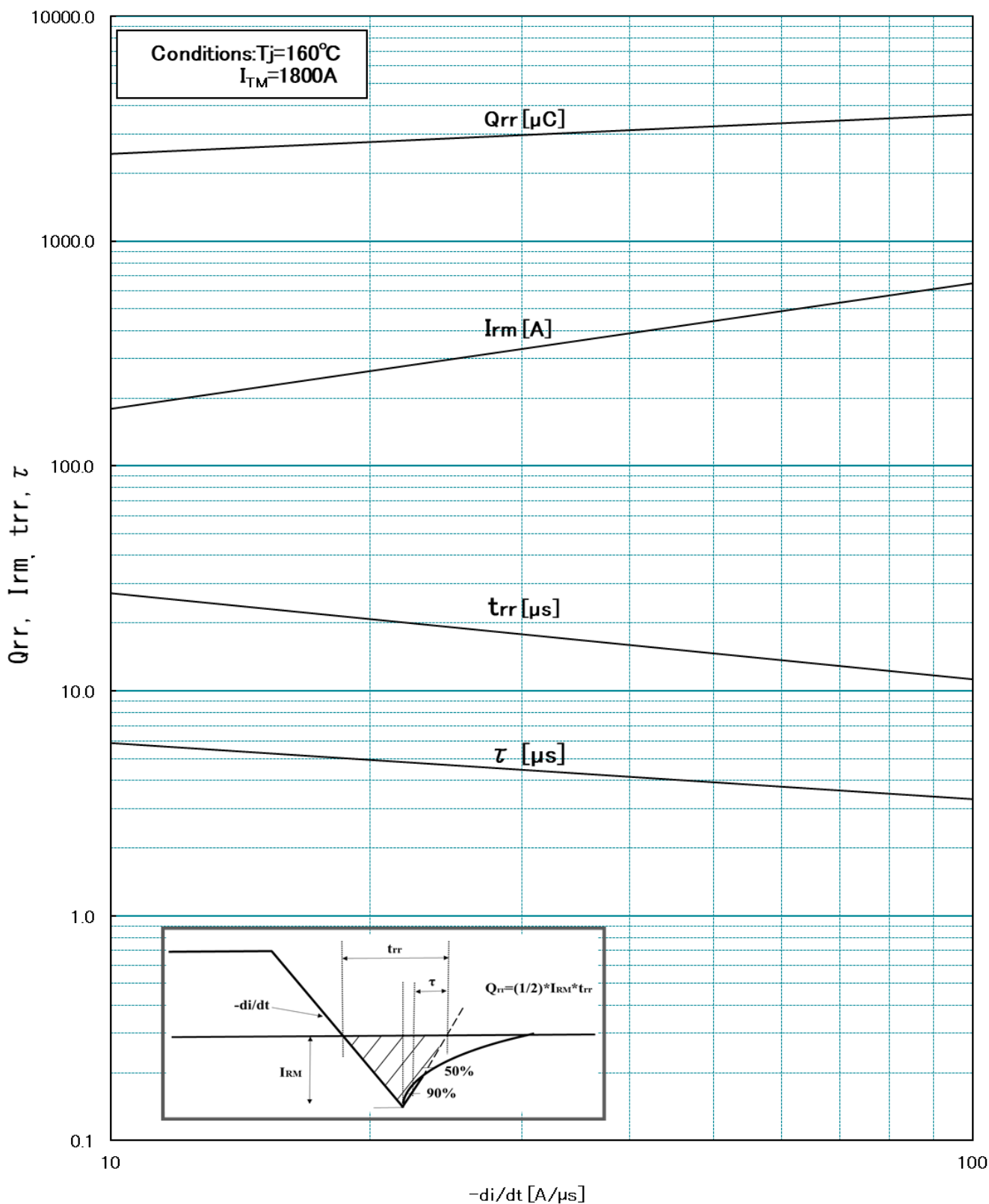

1

2

3

4

A

A

B

B

C

C

D



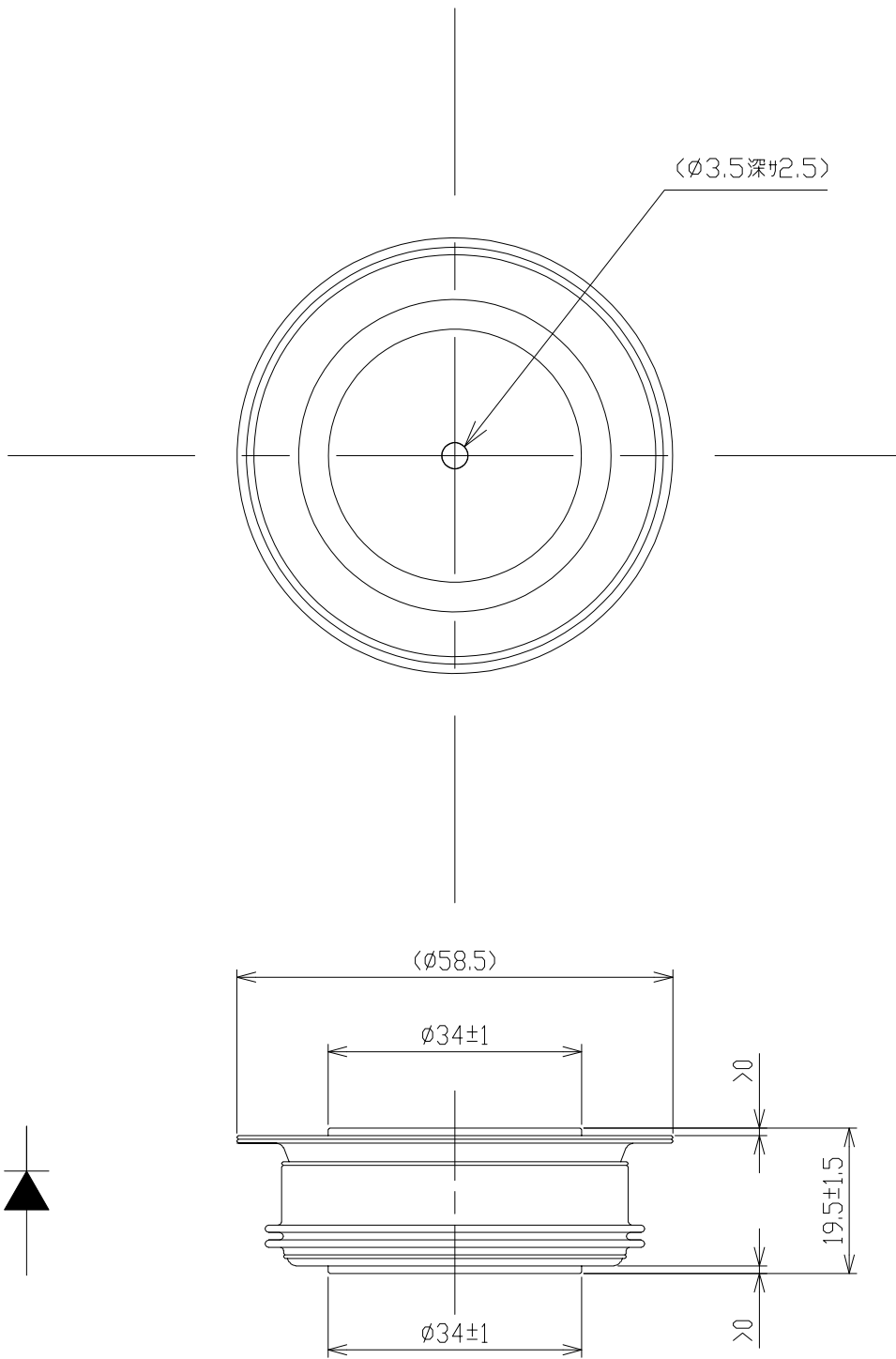

D

E

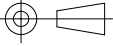
E



 SCALE 1:1
 UNIT: mm

								Q A	APPD. 承認	朝 倉
								作成部署	APPD. 承認	北 西
							CHKD. 検閲		松 山	
							DWN. 作図		武 田	
							DATE 年月日		23.04.21	
REV. 変更記号	REVISION 改訂	DATE 年月日	REV.D. 担当	APPD. 承認	QA APPD. QA承認	SORT 種類	外形寸法図		DRG.No.: 図番	



TITLE: 型名
I1748PJA250

DRG.No.: 図番
QMS7308-23-70001-33

REV.
変更記号

1

2

3

4

F

F