

# ダイオード製品仕様書

## DIODE DATA SHEET

仕様書No.QMS7301-302-A0087 (1/5)

I1074PJA260

### 最大定格 Maximum Ratings

項目 Item	記号 symbol	条件 Condition	定格 Rating	Unit
くり返しピーク逆電圧 Repetitive peak reverse voltage	$V_{RRM}$		2600	V
非くり返しピーク逆電圧 Non-repetitive peak reverse voltage	$V_{RSM}$		2700	V
平均順電流 Average forward current	$I_{O(AV)}$	50Hz Half sine wave, 180° 通電 $T_f=59^{\circ}\text{C}$	800	A
実効順電流 RMS forward current	$I_{F(RMS)}$		1257	A
非繰り返しサージ順電流 Non-repetitive Surge forward current	$I_{FSM}$	50Hz Half sine wave, 1cycle, $V_R=0\text{V}$ $T_j(\text{initial})=160^{\circ}\text{C}$	6100	A
電流二乗時間積 I <sup>2</sup> t capacity	$I^2t$	2~10ms	$1.80 \times 10^5$	A <sup>2</sup> s
動作接合温度範囲 Operating junction temperature range	$T_{jw}$		-40~+160	°C
保存温度範囲 Storage temperature range	$T_{stg}$		-40~+160	°C
圧接力 Mounting force	F	()内は推奨値 ()Recommended Value	8.3 (6.9)	kN

### 電気的特性 (指定なき場合は $T_j=25^{\circ}\text{C}$ ) Electric Characteristics ( $T_j=25^{\circ}\text{C}$ :Unless otherwise specified)

項目 Item	記号 Symbol	条件 Condition	Min.	Typ.	Max.	Unit
ピーク順電圧 Peak forward voltage	$V_{FM}$	$T_j=25^{\circ}\text{C}$ , $I_{FM}=2500\text{A}$	-	-	2.19	V
しきい値電圧 Threshold voltage	$V_{TO}$	$I_{F(AV)} \sim \pi \cdot I_{F(AV)}$ , $T_j=160^{\circ}\text{C}$	-	-	1.19	V
微分抵抗 Slope resistance	$r_t$	$I_{F(AV)} \sim \pi \cdot I_{F(AV)}$ , $T_j=160^{\circ}\text{C}$	-	-	0.57	mΩ
ピーク逆電流 Peak reverse current	$I_{RRM}$	$T_j=160^{\circ}\text{C}$ , $V_R=V_{RRM}$	-	-	30	mA

### 熱特性 Thermal Characteristics

項目 Item	記号 Symbol	条件 Condition	Min.	Typ.	Max.	Unit
熱抵抗 (接合部ーフィン間) Thermal resistance junction to Fin	$R_{th(j-f)}$	Double side cooled, With greased	-	-	0.05	°C/W

### 重量 Weight

項目 Item	記号 Symbol	条件 Condition	Min.	Typ.	Max.	Unit
重量 Weight	$W_t$		-	85	-	g

\* 本製品は一般的な電子機器に使用されることを意図しております。極めて高度な信頼性が要求され、その製品の故障や誤動作が直接人命に関わるような機器・装置へのご使用を検討される際は、事前に弊社営業窓口までご相談願います。

\* 当仕様書は事前の通知なく改正される事があります。正式採用時には承認図をご請求の上、仕様の確認をして下さい。

Descriptions in this specification are subject to change without announcement.

This product should not be used in any applications requiring extremely higher reliability, where a failure of the product or any consequences of the use of there of can reasonably be expected to result in personal injury or fatal accident, without any prior approval by Kyocera.

順電圧特性  
FORWARD CURRENT VS. VOLTAGE

I1074PJA260

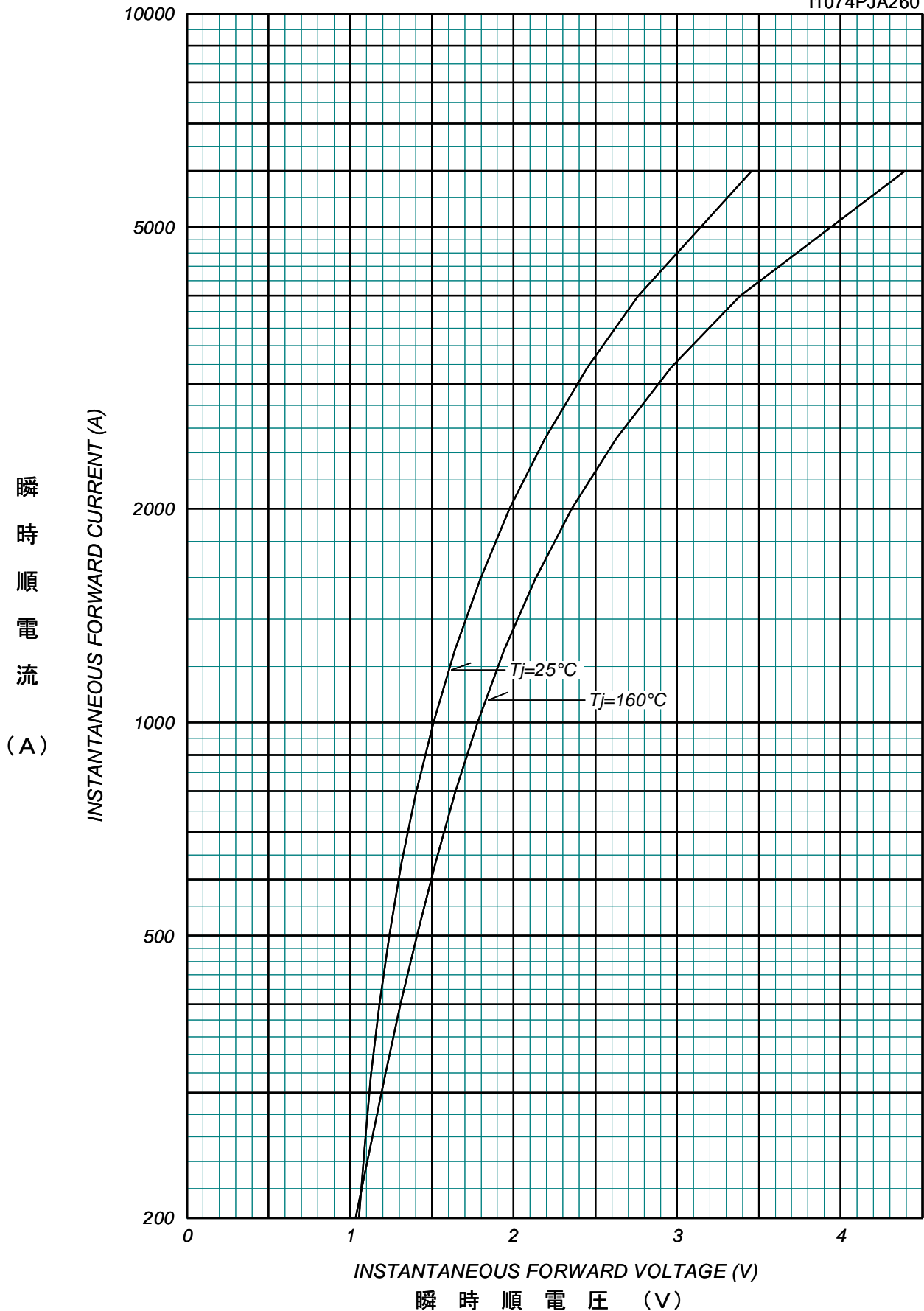

### 平均順電力損失特性

#### AVERAGE FORWARD POWER DISSIPATION

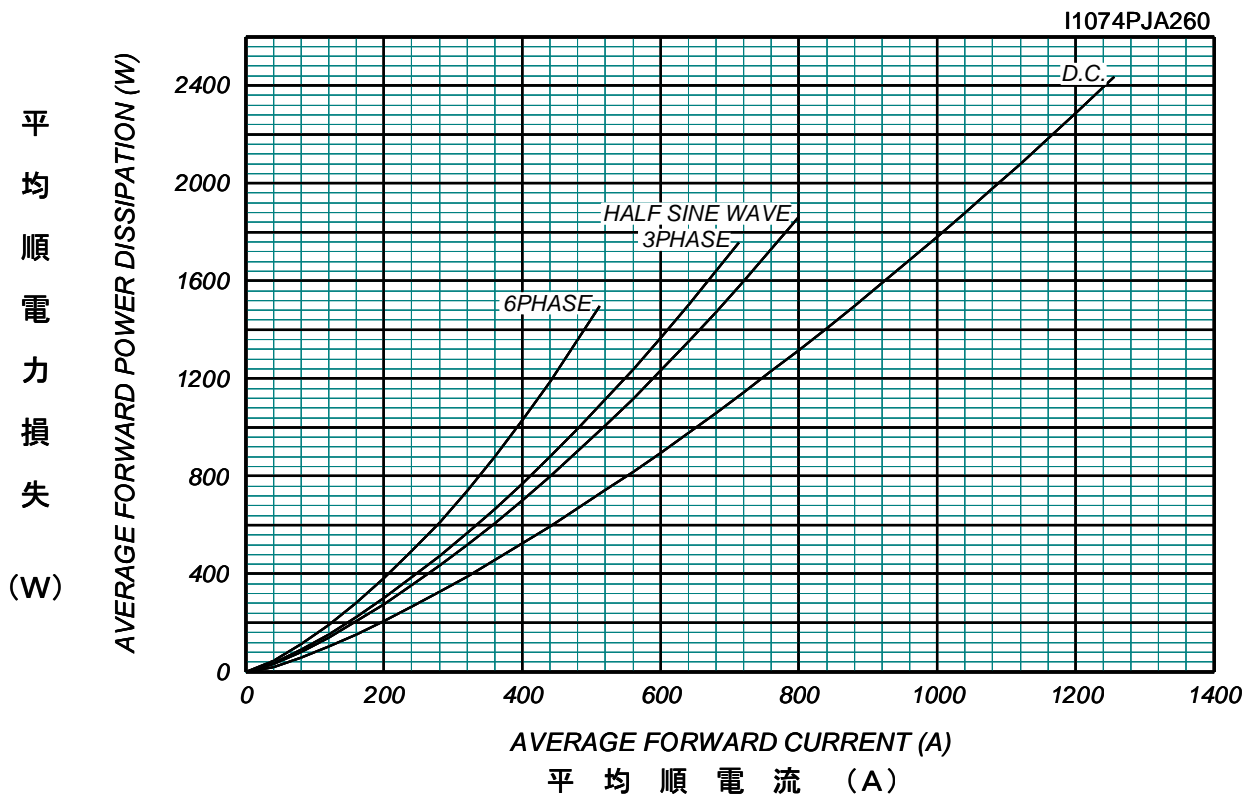

### 平均順電流 - フィン温度定格

#### AVERAGE FORWARD CURRENT VS. FIN TEMPERATURE

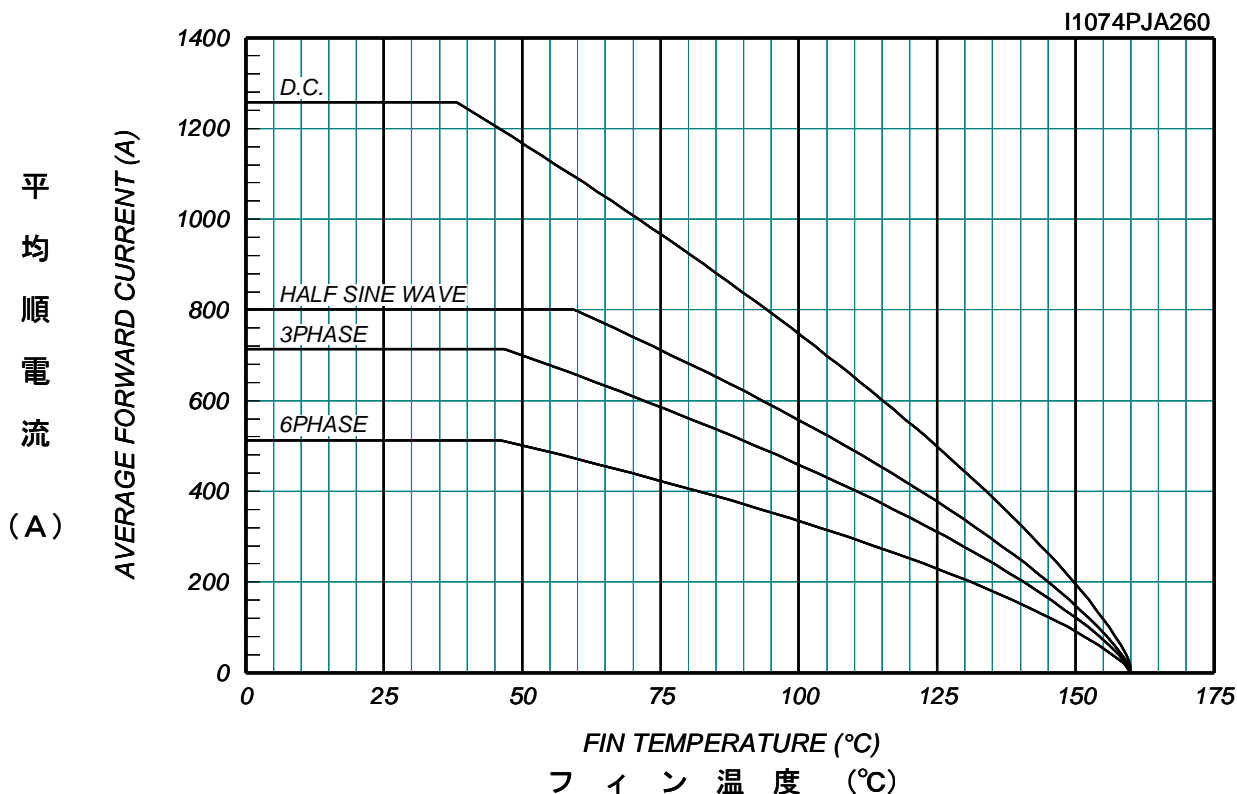

### サージ順電流定格

#### SURGE CURRENT RATINGS

f=50Hz,Half Sine Wave,Non-Repetitive,On Load

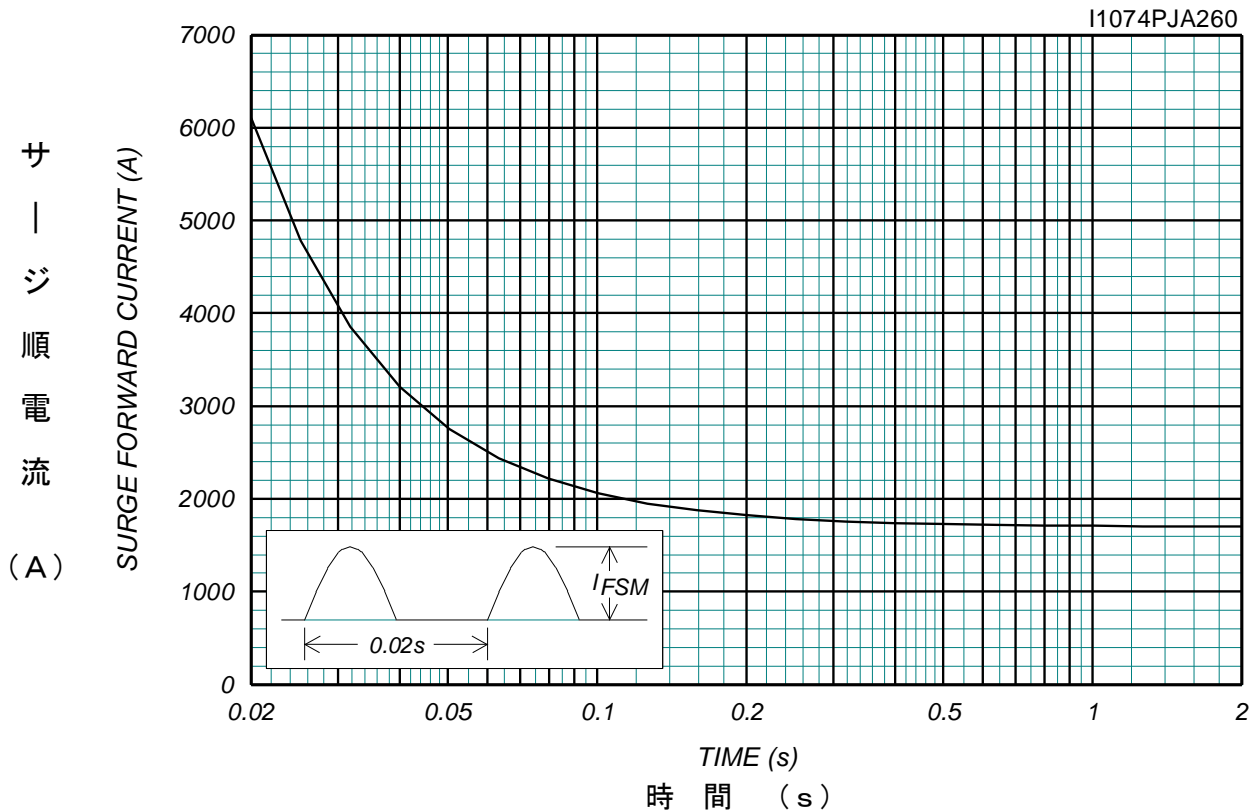

### 過渡熱抵抗特性

#### Transient Thermal Impedance

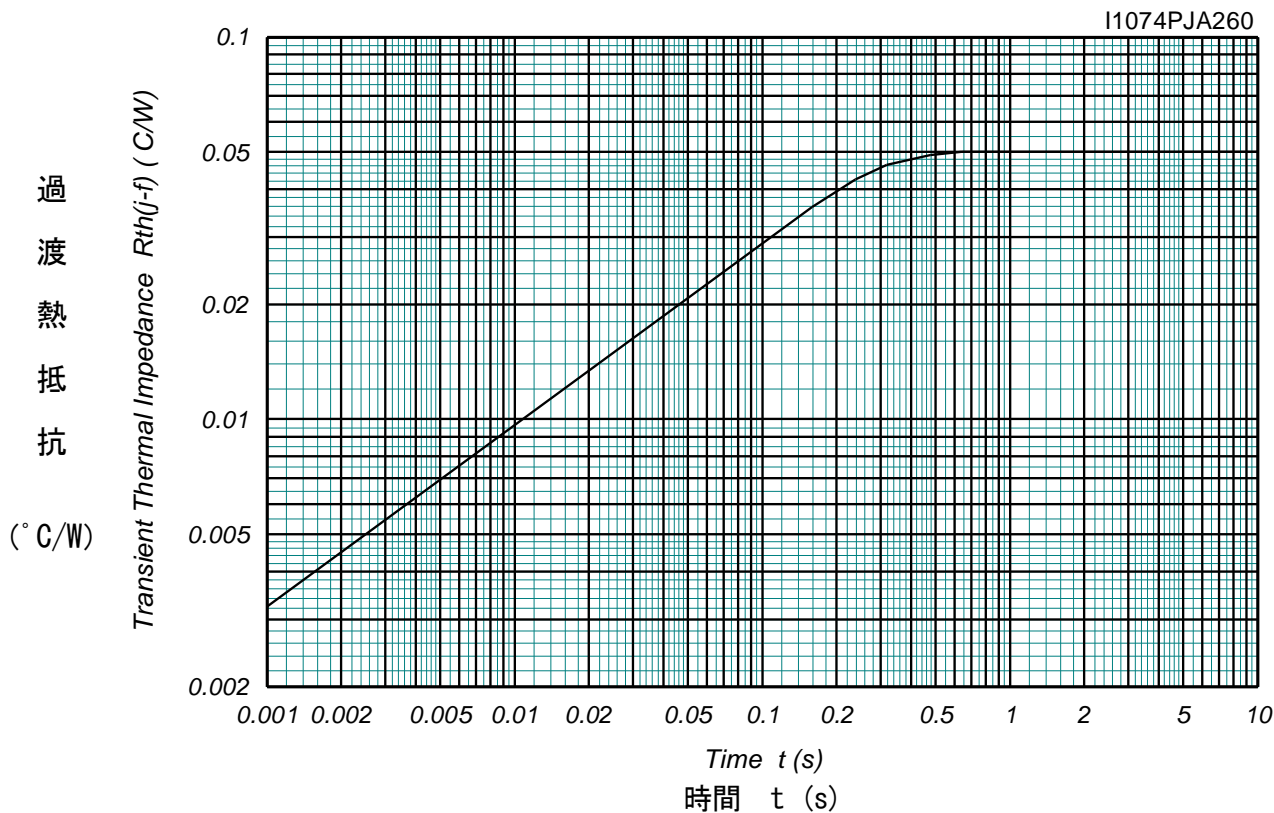

## 逆回復特性

### Reverse Recovery Characteristics

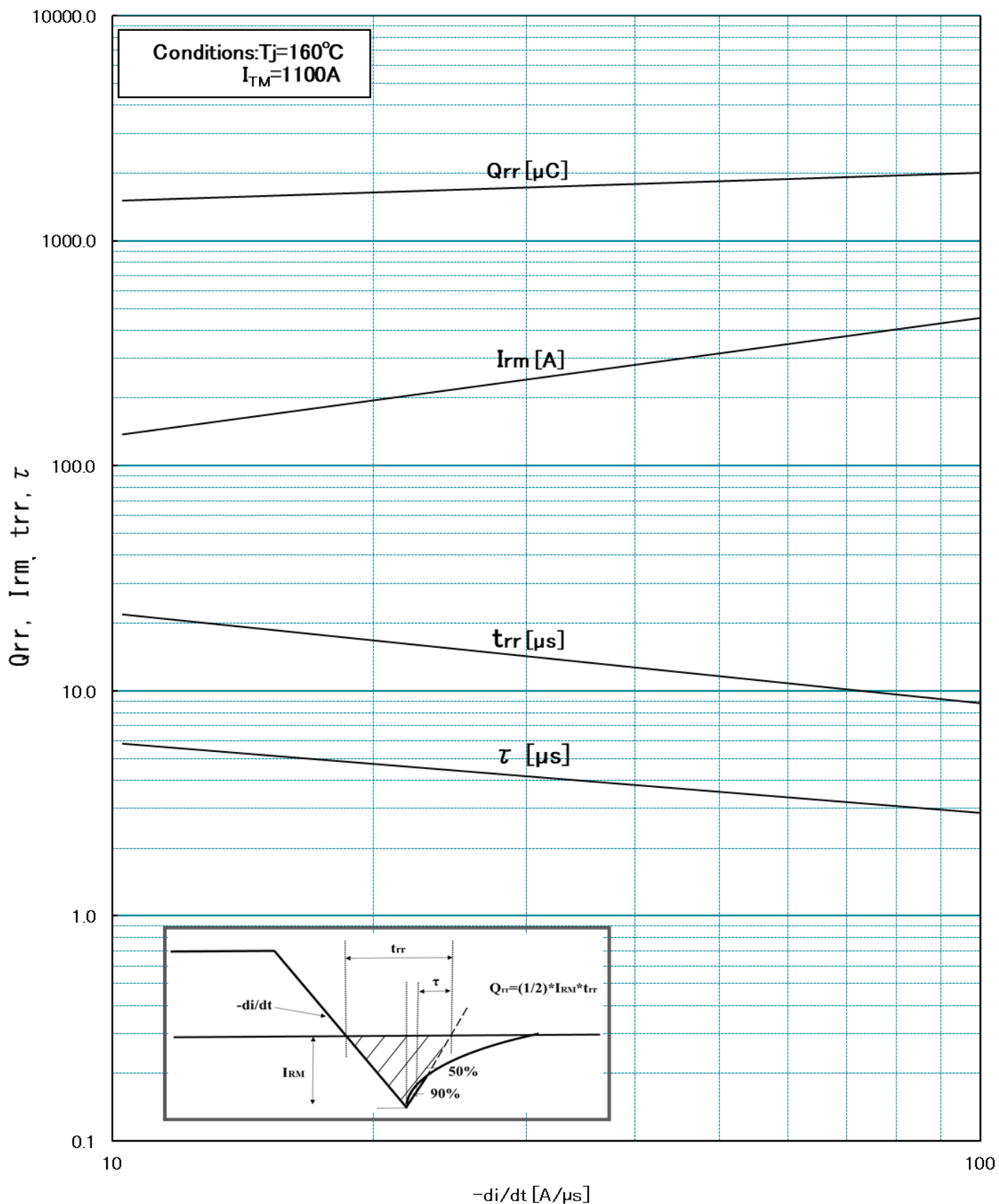

1

2

3

4

A

A

B

B

C

C

D



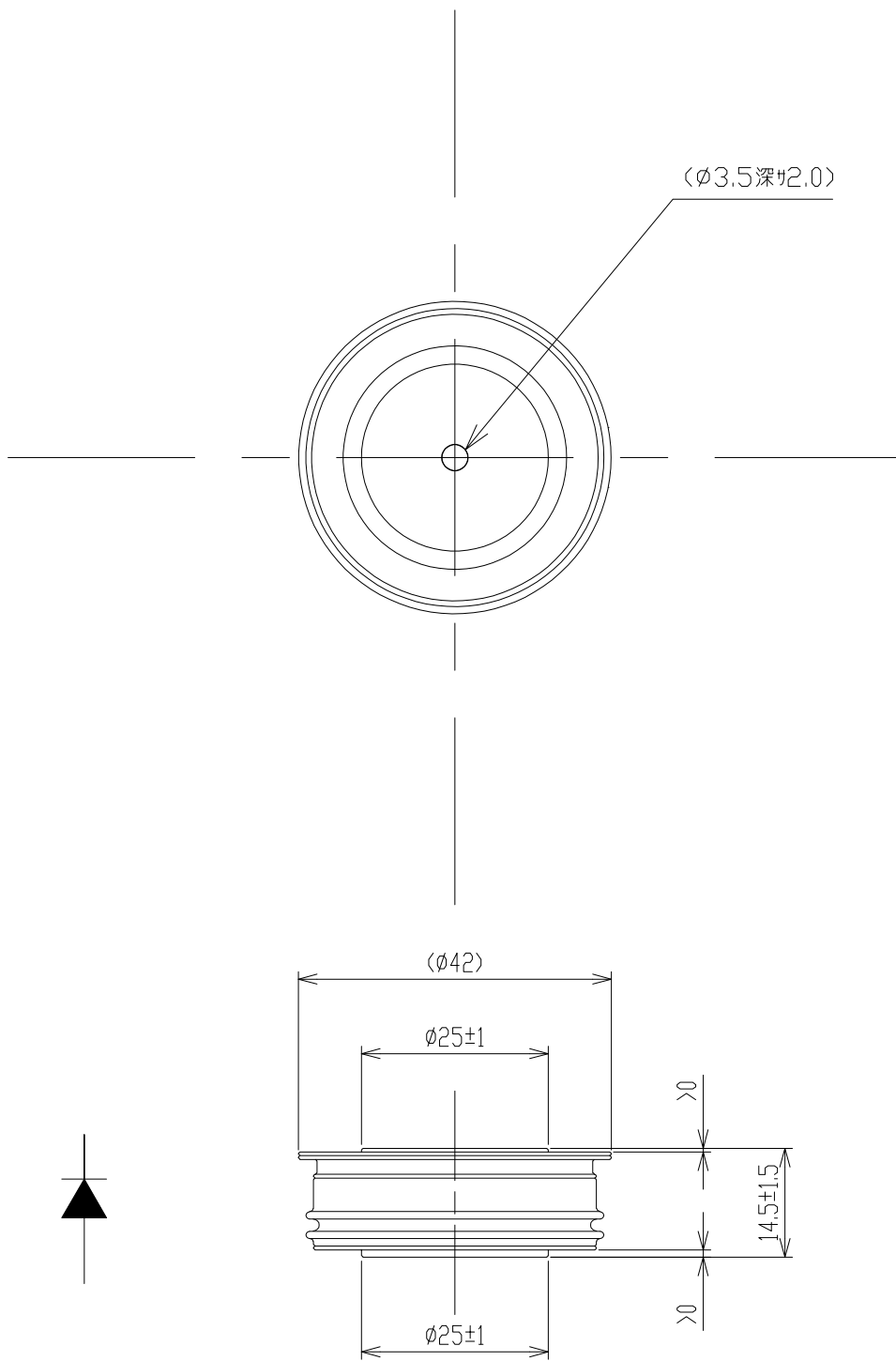

D

E

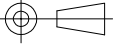
E



  
 SCALE 1:1  
 UNIT: mm

								Q A	APPD. 承認	朝 倉
								作成部署	APPD. 承認	北 西
							CHKD. 検閲		松 山	
							DWN. 作図		武 田	
							DATE 年月日		23.04.21	
REV. 変更記号	REVISION 改訂	DATE 年月日	REV.D. 担当	APPD. 承認	QA APPD. QA承認	SORT 種類	外形寸法図		QMS7308-23-70001-28	



TITLE: 型名  
I1074PJA260

DRG.No.: 図番  
QMS7308-23-70001-28

REV.  
変更記号  

1

2

3

4

F

F