

ROHS規制対応
COMPLIANT WITH
ROHS REGULATIONS

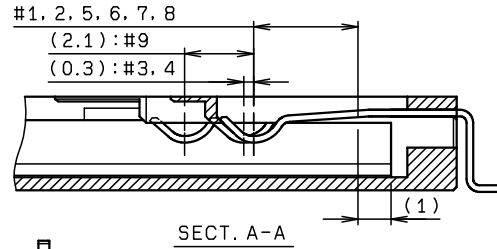

NO.	DESCRIPTION	PART NO.	QTY	MATERIAL	DRW NO.	REMARKS
1	INSULATOR		1	HEAT RESISTANT RESIN		UL94-V0
2	CONTACT		9	PHOS-BRONZE		Au
3	WRITE PROTECT CONTACT		1	PHOS-BRONZE		Au
4	GROUND CONTACT		1	PHOS-BRONZE		Au
5	CARD DETECT CONTACT		1	PHOS-BRONZE		Au
6	EJECT BAR		1	HEAT RESISTANT RESIN		UL94-V0
7	COIL SPRING		1	SUS		
8	HOOK PLATE		1	PHOS-BRONZE		Ni
9	CAM PLATE		1	SUS		
10	RIVET		1	SUS		
11	ANCHOR PLATE		1	BRASS		Ni, Sn-Cu

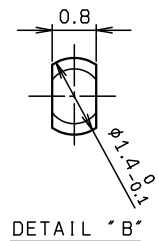
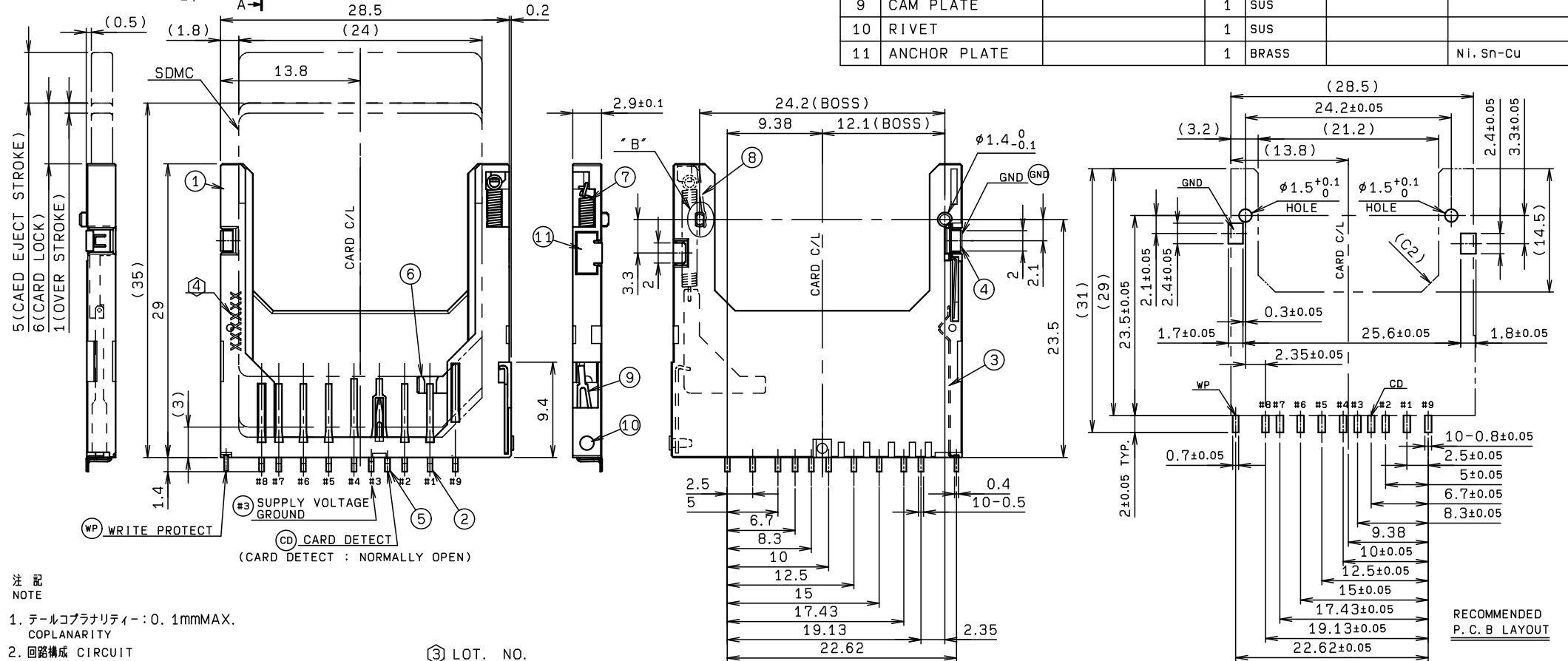

注記
NOTE
1. テールコプラナリティー: 0.1mmMAX.
COPLANARITY
2. 回路構成 CIRCUIT

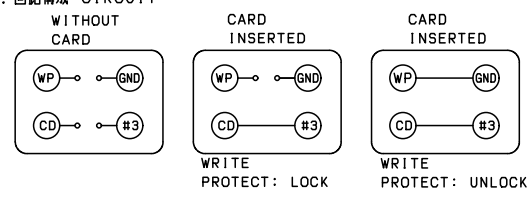

LOT. NO. XXXXXX
製造場所コード PRODUCT PLACE NO. EA: 中国工場
日 DAY
月 MONTH (1~9, X, Y, Z)
年 YEAR (A. D. 2000~: A, B, C, D, E, F, G, H, J, K
2010~: 0, 1, 2, 3, 4, 5, 6, 7, 8, 9
2020~: A, B, C, D, E, F, G, H, J, K)

※この注記の1~3は1ページ目のみ適用
※THIS NOTES 1 TO 3 ARE APPLICABLE TO SHEET-1 ONLY.

TOLERANCE / 一般公差(S)		PRODUCT SPEC / 製品規格		B DCN20652		2020/06/29		K. YOSHIDA		F. I. KEGAMI	
X < 10	±0.2			A DCN-185	2017/02/14		H. NAKAMURA		Y. OKABE		
10 ≤ X < 30	±0.25	UNIT	ANGLE	O EDN-236	2006/03/03		A. SATO		N. HAYASHI		
30 ≤ X	±0.3	mm	3RD	NO.	EDN/DCN	DATE	ISSUE	CHECKED	APPROVED		
ANGLE / 角度 ±3°		SCALE	DATE	PART NAME / 品名							
		NTS	2006/03/03	SERIES 5638							
		CHECKED	APPROVED	SDMC ASSY TYPE REVERSE SPRING EJECT							
DRAWN T. KOMATSU		DESIGNED A. SATO		PART NO. / 製番		14 5638 109 511 859 +					
				DWG NO. / 図番		BJS 5638031					
								SHEET/REV		1/2 B	

© 2020 KYOCERA Corporation

NO.	DESCRIPTION	PART NO.	QTY	MATERIAL	DRW NO.	REMARKS
1	CONNECTOR	14 5638 109 511 859 +	250			10 5638 109 511 859 +
2	EMBOSS TAPE		1	POLYSTYRENE (CLEAR)		
3	TOP COVER TAPE		1	POLYSTYRENE		
4	REEL		1	POLYSTYRENE		

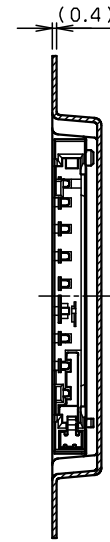
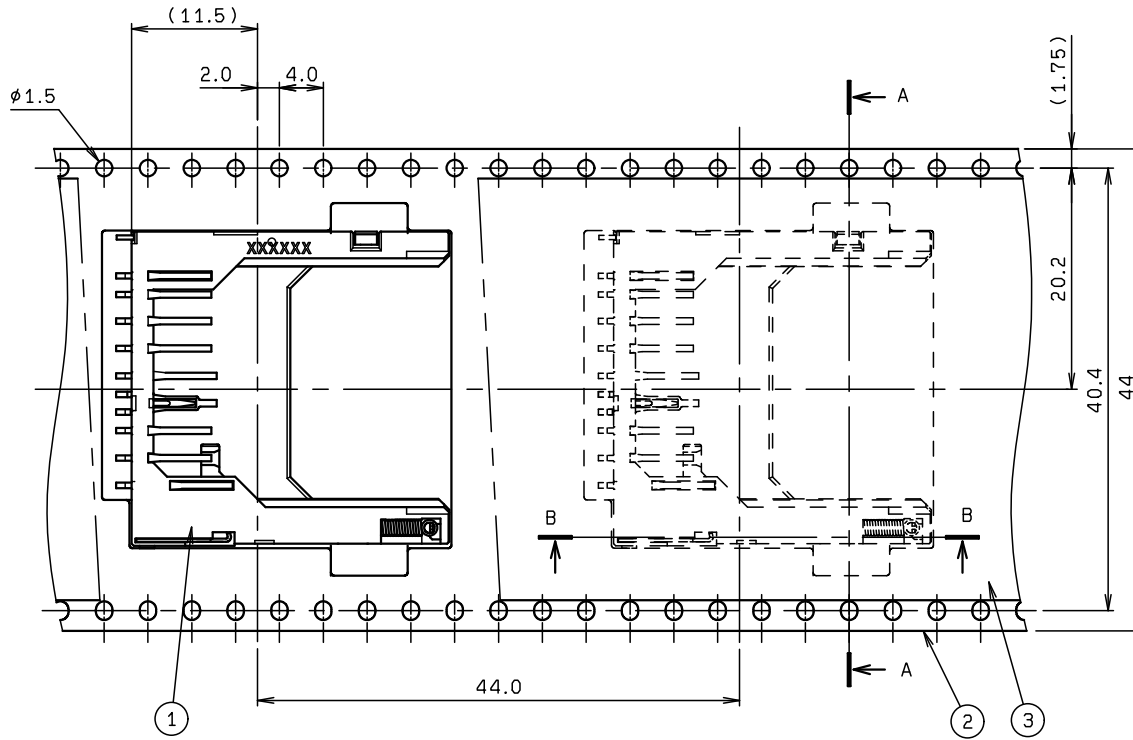

SECT. A-A

注記
NOTE

1. 梱包数量 : 250 個/リール
PACKING QUANTITY : 250 ea/reel

2. 納入時のリール巻き方向
DIRECTION OF REEL

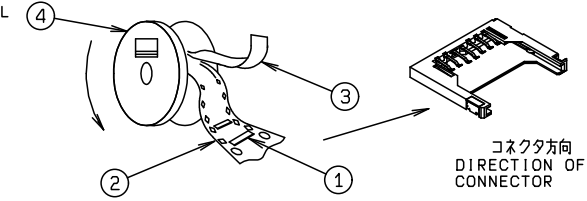

3. 引出し方向
USER DIRECTION OF FEED

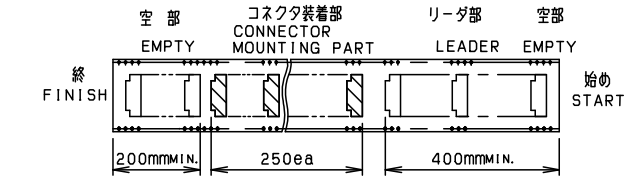

4. 型番
P/N 14 5638 109 511 859 +

種数
NO. OF POS.

※この注記の1~3は2ページ目のみ適用
※THIS NOTES 1 TO 3 ARE APPLICABLE TO SHEET-2 ONLY.

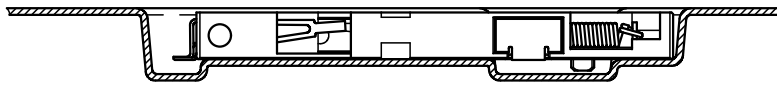

SECT. B-B (S=3:1)

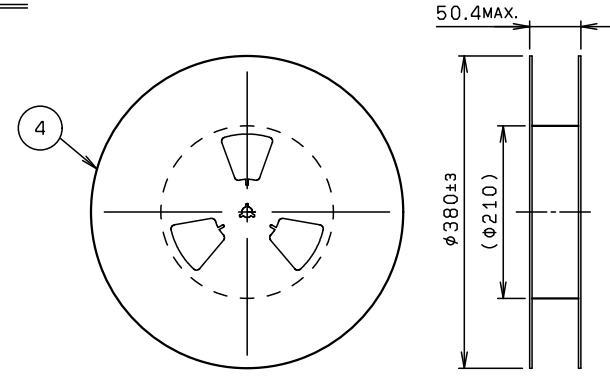

REEL DIMENSION

ROHS規制対応
COMPLIANT WITH
ROHS REGULATIONS

TOLERANCE / 一般公差 (S)		PRODUCT SPEC / 製品規格		REFER TO SHEET 1/2		NO.		EDN/DCN		DATE		ISSUE		CHECKED		APPROVED	
X < 10	±0.2	UNIT	ANGLE	mm	3RD												
10 ≤ X < 30	±0.25																
30 ≤ X	±0.3																
ANGLE / 角度 ±3°		SCALE		DATE		PART NAME / 品名		SERIES 5638		EMBOSS TAPE ASSY		SDMC ASSY TYPE		REVERSE SPRING EJECT			
DRAWN	DESIGNED	CHECKED	APPROVED	PART NO. / 型番		14 5638 109 511 859 +		DWG NO. / 図番		BJS 5638031		SHEET/REV		2/2		B	
T. KOMATSU	A. SATO		N. HAYASHI														

