

## How to Order

### ■ Features

- Kyocera's series of Multilayer Ceramic Chip Capacitors are designed to meet a wide variety of needs. We offer a complete range of products for both general and specialized applications.
- We have a network worldwide in order to supply our global customer bases quickly and efficiently.
- All our products are highly reliable due to their monolithic structure of high-purity and superfine uniform ceramics and their integral internal electrodes.
- Our stringent quality control in every phase of production from material procurement to shipping ensures consistent manufacturing and superior quality.
- Kyocera components are available in a wide choice of dimensions, temperature characteristics, rated voltages, and terminations to meet specific configurational requirements.

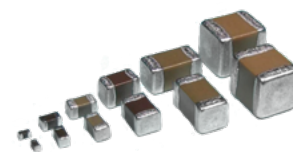

e.g.)

**KGM** **03** **C** **R5** **0J** **225** **M** **H** □□□□  
 ① ② ③ ④ ⑤ ⑥ ⑦ ⑧ Option Code (When needed)

- ① Series : KGM Series(General)
- ② Size (EIA) : 0201
- ③ Thickness (max.) : 0.39mm
- ④ Dielectric : Operating Temperature Range: -55 to 85°C/  
ΔC max.: ±15%/ Standard Temperature: 25°C
- ⑤ Rated Voltage : 6.3Vdc
- ⑥ Capacitance : 2.2μF
- ⑦ Tolerance : ±20%
- ⑧ Packaging : Taping Material Paper/ Taping Width 8mm/  
Cavity Pitch 2mm/ Reel Size φ180

#### ① Series Code

CODE	Type
KGM	General
KGT	Low Profile
KGU	High-Q
KAM	Automotive
KGN	Three Terminal Capacitors

#### ② Size Code

CODE	EIA	JIS
02	01005	0402
03	0201	0603
05	0402	1005
15	0603	1608
21	0805	2012
31	1206	3216
32	1210	3225

#### ③ Thickness (max.)

CODE	EIA	JIS	Thickness Code	Thickness(max.)
02	01005	0402	A	0.22
03	0201	0603	A	0.33
			B	0.35
			C	0.39
			D	0.55
			Y	0.22
05	0402	1005	A	0.55
			B	0.65
			C	0.7
			D	0.8
			X	0.22
			Y	0.33
			Z	0.5
15	0603	1608	A	0.9
			C	1.0
			A	1.45
21	0805	2012	C	0.95
			A	1.8
31	1206	3216	F	1.75
			H	1.9
			L	0.95
			A	2.7
32	1210	3225	A	2.7

#### ④ Dielectric Code

Temperature Compensation Type			
CODE	Temperature Range(°C)	ppm/°C	
CG	-55 ~ 125	0	±30
CH			±60

· All parts of COG will be marked as "CG" but will conform to the above table.  
 · Temperature coefficients are determined by calculation based on measurement at 20°C and 85°C.

High Dielectric Constant Type			
CODE	Temperature Range(°C)	ΔC (%)	Reference Temp.°C
R5	-55 ~ 85	±15	25
S6		±22	
T6	-55 ~ 105	+22/-33	
R7		±15	
K7*	-55 ~ 125	±15	
S7		±22	
T7		+22/-33	

\*Special spec: Change in capacitance under 50% of rated voltage applied.

Measurement conditions for temperature characteristics K7.

Applied voltage and Temperature step

Step	C	Applying Voltage	Temperature°C
1	C0	No bias	Reference Temp.
2	—	50% of Rated voltage	Reference Temp.
3	C1		Min. Operating Temp.
4	C2		Reference Temp.
5	C1		Max. Operating Temp.

ΔC/C(%)=(C1-C2)/C0 × 100  
 C0:Capacitance value at step 1  
 C1:Capacitance value from step 3 to 5  
 C2:Capacitance value at step 4

#### ⑤ Voltage Code

CODE	Rated Voltage	CODE	Rated Voltage
0E	2.5Vdc	1E	25Vdc
0G	4Vdc	1V	35Vdc
0J	6.3Vdc	1H	50Vdc
1A	10Vdc	2A	100Vdc
1C	16Vdc		

#### ⑥ Capacitance Code

Capacitance expressed in pF.  
 Two significant digits plus number of zeros.  
 For Values < 10pF, Letter R denotes decimal point,

(Example)

CODE	Capacitance	CODE	Capacitance
R50	0.5pF	103	10000pF
1R0	1pF	104	0.1μF
100	10pF	105	1μF
101	100pF	106	10μF
102	1000pF	107	100μF

#### ⑦ Tolerance Code

Temperature Compensation Type(CG/CH)	
CODE	Tolerance
A*	±0.05pF
B	±0.1pF
C	±0.25pF
D	±0.5pF
G*	±2%
J	±5%
K	±10%

\* : Option

High Dielectric Constant Type (R5/S6/T6/R7/K7/S7/T7)	
CODE	Tolerance
J*	±5%
K	±10%
M	±20%

\* : Option

#### ⑧ Packaging Code

CODE	Size Code	Material	Width	Pitch	Reel size
T	15 to 31	Paper	8mm	4mm	φ180
H	02 to 05	Paper	8mm	2mm	
Q	03	Paper	8mm	1mm	
U	21 to 32	Plastic	8mm	4mm	
P	02	Plastic	4mm	1mm	
M	15 / 21	Paper	8mm	4mm	φ330
N	02 to 05	Paper	8mm	2mm	
W	03	Paper	8mm	1mm	
L	21 to 32	Plastic	8mm	4mm	

## Dimension

### ■KGM/KGT/KGU/KAM Series (Two Terminal Capacitors)

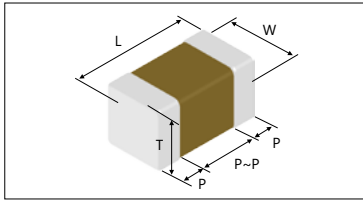

### ■Packaging Code

20kp ( E 8 / 2 )

kp means 1000 pieces

Code	Material	Taping Width		Pitch	
		Code	Width	Code	Pitch
E	Plastic	4	4mm	1	1mm
P	Paper	8	8mm	2	2mm
				4	4mm

Size	Code		Thickness Code	Dimension (mm)						Quantity per reel			
	EIA	JIS		L	W	T	P min.	P max.	P ~ P min.	φ180 Reel	φ330 Reel		
02	01005	0402	A	0.4±0.02	0.2±0.02	0.2±0.02	0.07	0.14	0.13	40kp(E4/1) 20kp(P8/2)	— 80kp(P8/2)		
03	0201	0603	Y	0.6±0.03	0.3±0.03	0.22 max.	0.1	0.2	0.2	30kp(P8/1) 15kp(P8/2)	150kp(P8/1) 50kp(P8/2)		
			A			0.3±0.03							
			B	0.6±0.05	0.3±0.05	0.22 max.	0.13	0.23	0.19	15kp(P8/2)	50kp(P8/2)		
			Y*	0.6±0.09	0.3±0.09	0.3±0.09							
			C			0.5±0.05							
05	0402	1005	Y	1.0±0.05	0.5±0.05	0.33 max.	0.15	0.35	0.3	10kp(P8/2)	50kp(P8/2)		
			A			0.5±0.05							
			X	1.0±0.1	0.5±0.05	0.22 max.						10kp(P8/2)	50kp(P8/2)
			B	1.0±0.15	0.5±0.15	0.5±0.15							
			Y*	1.0±0.2	0.5±0.2	0.33 max.						10kp(P8/2)	50kp(P8/2)
			Z			0.5 max.							
			A*			0.55 max.							
			C			0.5±0.2							
			D	0.8 max.	10kp(P8/2)	30kp(P8/2)							
			15	0603	1608	A						1.6±0.1	0.8±0.1
C	1.6±0.2	0.8±0.2				0.8±0.2							
21	0805	2012	C	2.0±0.2	1.25±0.2	0.95 max.	0.2	0.75	0.7	4kp(P8/4)	10kp(P8/4)		
			A			1.25±0.2							
31	1206	3216	L	3.2±0.2	1.6±0.2	0.95 max.	0.3	0.85	1.4	4kp(P8/4)	—		
			F			1.6±0.15						1.6±0.15	
			A	3.2±0.2	1.6±0.2	1.6±0.2						2.5kp(E8/4)	5kp(E8/4)
			H			3.2±0.3							
32	1210	3225	A	3.2±0.3	2.5±0.2	2.5±0.2	0.3	1.0	1.4	1kp(E8/4)	4kp(E8/4)		

※ If there is a "\*" in the thickness code, thickness (T- dimension) is the same but the L/W dimension are different. Please refer to the parts number list for details.

### ■KGN Series (Three Terminal Capacitors)

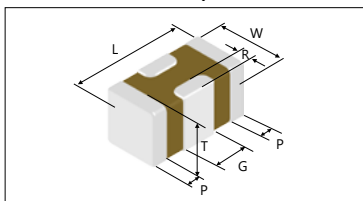

Size	Code		Thickness Code	Dimension (mm)						Quantity per reel	
	EIA	JIS		L	W	T	G	P	R	φ180 Reel	φ330 Reel
KGN 05	0402	1005	Z	1.0±0.1	0.5±0.2	0.5 max.	0.3±0.1	0.15±0.1	≥0.05	10kp(P8/2)	—
			B	1.0±0.15	0.5±0.15	0.5±0.15					
			C	1.0±0.2	0.5±0.2	0.5±0.2					

## ■ Features

0402 Size. Rated current up to 2A MAX.  
 With unique circuit structure, this three terminal capacitor enables noise reduction in wide frequency range. With its high capacitance, it is possible to reduce the number of components being used.

## ■ Applications

- Decoupling applications of power supply lines around high-speed operating processors such as smartphones, tablets, and wearable devices.

## R5 Dielectric

● Capacitance chart ■ Standard Spec. 1

R5				
Capacitance	105	435	106	156
Size/Voltage(Vdc)	1μF	4.3μF	10μF	15μF
KGN05 (0402)	4	Z	C	B

Please contact for capacitance value other than standard.  
 Please refer to [here](#) for the test method and specifications of Standard Specification 1.

The code in the capacity range table means product thickness (T-dimension). Please refer to the below parts number list. For details about T dimensions, please refer to the Dimension section in the parts number list below.

(Example) In case of "Z" for KGN05;  
 T: 0.5mm max.

Parts number list 3-Terminal KGN05 Series Temperature Characteristic: R5 Tolerance : M: ±20%

Thickness code	Part Number	Capacitance	Tolerance	Voltage [V]	Dimension [mm]			Packaging							
								Φ180				Φ330			
					L	W	T	code	QTY	code	QTY	code	QTY	code	QTY
<b>Z</b>	KGN05ZR50G435MH	4.3μF	M	4	1.0±0.1	0.5±0.2	0.5 max.	H	10kp	-	-	-	-	-	-
<b>C</b>	KGN05CR50G106MH	10μF	M	4	1.0±0.2	0.5±0.2	0.5±0.2	H	10kp	-	-	-	-	-	-
<b>B</b>	KGN05BR50G156MH	15μF	M	4	1.0±0.15	0.5±0.15	0.5±0.15	H	10kp	-	-	-	-	-	-

## S6 Dielectric

● Capacitance chart ■ Standard Spec. 1

S6				
Capacitance	105	435	106	156
Size/Voltage(Vdc)	1μF	4.3μF	10μF	15μF
KGN05 (0402)	2.5	Z	C	
	4	Z		

Please contact for capacitance value other than standard.  
 Please refer to [here](#) for the test method and specifications of Standard Specification 1.

The code in the capacity range table means product thickness (T-dimension). Please refer to the below parts number list. For details about T dimensions, please refer to the Dimension section in the parts number list below.

(Example) In case of "Z" for KGN05;  
 T: 0.5mm max.

Parts number list 3-Terminal KGN05 Series Temperature Characteristic: S6 Tolerance : M: ±20%

Thickness code	Part Number	Capacitance	Tolerance	Voltage [V]	Dimension [mm]			Packaging							
								Φ180				Φ330			
					L	W	T	code	QTY	code	QTY	code	QTY	code	QTY
<b>Z</b>	KGN05ZS60G435MH	4.3μF	M	4	1.0±0.1	0.5±0.2	0.5 max.	H	10kp	-	-	-	-	-	-
<b>Z</b>	KGN05ZS60E435MH	4.3μF	M	2.5	1.0±0.1	0.5±0.2	0.5 max.	H	10kp	-	-	-	-	-	-
<b>C</b>	KGN05CS60E106MH	10μF	M	2.5	1.0±0.2	0.5±0.2	0.5±0.2	H	10kp	-	-	-	-	-	-

## ■ Dimension

(Unit: mm)

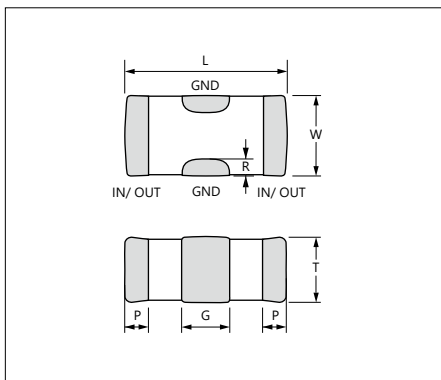

## ■ Recommended Land Pattern

(Unit: mm)

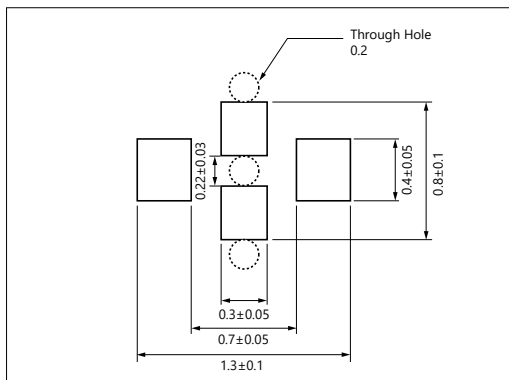

## Test Conditions and Standards

### Test Conditions and Specifications for High Dielectric Type (R5, S6) KGN Series (Standard Spec.1)

Test Items		Test Conditions (Complies with JIS C5101/ IEC60384)	Specifications											
Capacitance(C)		Measure after heat treatment <table border="1"> <thead> <tr> <th>Capacitance</th> <th>Frequency</th> <th>Volt</th> </tr> </thead> <tbody> <tr> <td rowspan="2">C ≤ 10μF</td> <td>1kHz±10%</td> <td>1.0±0.2Vrms</td> </tr> <tr> <td>*1kHz±10%</td> <td>0.5±0.2Vrms</td> </tr> <tr> <td>C &gt; 10μF</td> <td>120Hz±10%</td> <td>0.5±0.2Vrms</td> </tr> </tbody> </table> *KGN05CR50G106, KGN05CS60E106 The charge and discharge current of the capacitor must not exceed 50mA.	Capacitance	Frequency	Volt	C ≤ 10μF	1kHz±10%	1.0±0.2Vrms	*1kHz±10%	0.5±0.2Vrms	C > 10μF	120Hz±10%	0.5±0.2Vrms	Within specified tolerance
Capacitance	Frequency	Volt												
C ≤ 10μF	1kHz±10%	1.0±0.2Vrms												
	*1kHz±10%	0.5±0.2Vrms												
C > 10μF	120Hz±10%	0.5±0.2Vrms												
Insulation Resistance		Measure after applying rated voltage for 1 minute in normal temperature and humidity. The charge and discharge current of the capacitor must not exceed 50mA.	Over 50MΩ · μF											
Direct current resistance			0.03Ω max.											
Rated current			2A(DC)											
Dielectric Strength		Apply 2.5 times of the rated voltage for 1 to 5 seconds. The charge and discharge current of the capacitor must not exceed 50mA.	No problem observed											
Appearance		Microscope	No problem observed											
Bending Strength		Glass epoxy PCB; Fulcrum spacing: 90mm, duration time 10 seconds.	No significant damage with 1mm bending											
Vibration	Appearance	Take the initial value after heat treatment. Vibration frequency: 10 to 55 (Hz) Amplitude: 1.5mm	No problem observed											
	Capacitance	Sweeping condition: 10→55→10Hz/ 1 minute in X, Y and Z directions: 2 hours each, 6 hours in total, then measure the sample after heat treatment.	Within tolerance											
Resistance to Solder Heat	Appearance	Take the initial value after heat treatment. Soak the sample in 260°C±5°C solder for 10±0.5 seconds, and measure after heat treatment. (Pre-heating conditions before soak)	No problem observed											
	Capacitance Variation		Within±30.0%											
	IR	<table border="1"> <thead> <tr> <th>Order</th> <th>Temperature</th> <th>Time</th> </tr> </thead> <tbody> <tr> <td>1</td> <td>80 to 100°C</td> <td>2 minutes</td> </tr> <tr> <td>2</td> <td>150 to 200°C</td> <td>2 minutes</td> </tr> </tbody> </table>	Order	Temperature	Time	1	80 to 100°C	2 minutes	2	150 to 200°C	2 minutes	Over 50MΩ · μF		
	Order	Temperature	Time											
1	80 to 100°C	2 minutes												
2	150 to 200°C	2 minutes												
Dielectric Strength	The charge and discharge current of the capacitor must not exceed 50mA for IR and dielectric strength measurement.	Resist without problem												
Solderability		Soaking condition <table border="1"> <thead> <tr> <th>Solder Type</th> <th>Temperature</th> <th>Time</th> </tr> </thead> <tbody> <tr> <td>Sn-3Ag-0.5Cu</td> <td>245±5°C</td> <td>3±0.5 sec.</td> </tr> </tbody> </table>	Solder Type	Temperature	Time	Sn-3Ag-0.5Cu	245±5°C	3±0.5 sec.	Solder coverage : 95% min.					
Solder Type	Temperature	Time												
Sn-3Ag-0.5Cu	245±5°C	3±0.5 sec.												
Temperature Cycle	Appearance	Take the initial value after heat treatment. (Cycle)	No problem observed											
	Capacitance Variation	Lowest operation temperature (30 min.)→ Room temperature (3 min.)→ Highest operation temperature(30 min.)→ Room temperature (3 min.)	Within±30.0%											
	IR		Over 50MΩ · μF											
	Dielectric Strength	After 5 cycles, measure after heat treatment. The charge and discharge current of the capacitor must not exceed 50mA for IR and dielectric strength measurement.	Resist without problem											
Load Humidity	Appearance	Take the initial value after heat treatment.	No problem observed											
	Capacitance Variation	Apply rated voltage for 500+12/ -0 hours in 40°C±2°C and 90 to 95%RH, and measure after heat treatment. The charge and discharge current of the capacitor must not exceed 50mA for IR measurement.	Within±30.0%											
	IR		Over 10MΩ · μF											
Load Life	Appearance	Take the initial value after heat treatment.	No problem observed											
	Capacitance Variation	Apply 1.0 times the rated voltage at the highest operation temperature for 1000+12/ -0 hours, and measure after heat treatment. The charge and discharge current of the capacitor must not exceed 50mA for IR measurement.	Within±30.0%											
	IR		Over 10MΩ · μF											
Heat treatment		Expose sample in the temperature of 150+0/ -10°C for 1 hour and leave the sample in normal temperature and humidity for 24±2 hours.												

## Test Conditions and Standards

Substrate for Adhesion Strength Test, Vibration Test, Soldering Heat Resistance Test, Temperature Cycle Test, Load Humidity Test, High-Temperature with Loading Test.

(Unit: mm)

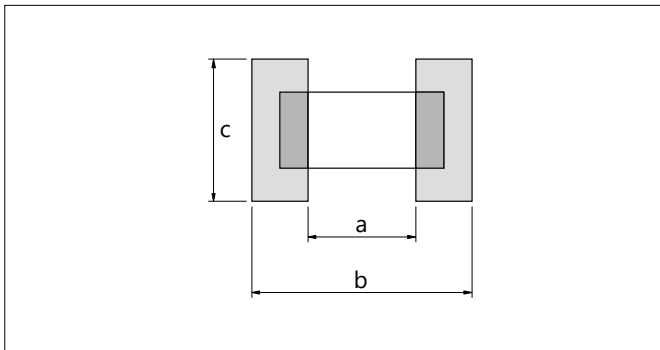

Size (EIA Code)	a	b	c
02 (01005)	0.15	0.5	0.2
03 (0201)	0.26	0.92	0.32
05 (0402)	0.4	1.4	0.5
15 (0603)	1.0	3.0	1.2
21 (0805)	1.2	4.0	1.65
31 (1206)	2.2	5.0	2.0
32 (1210)	2.2	5.0	2.9

### Substrate for Bending Test

(Unit: mm)

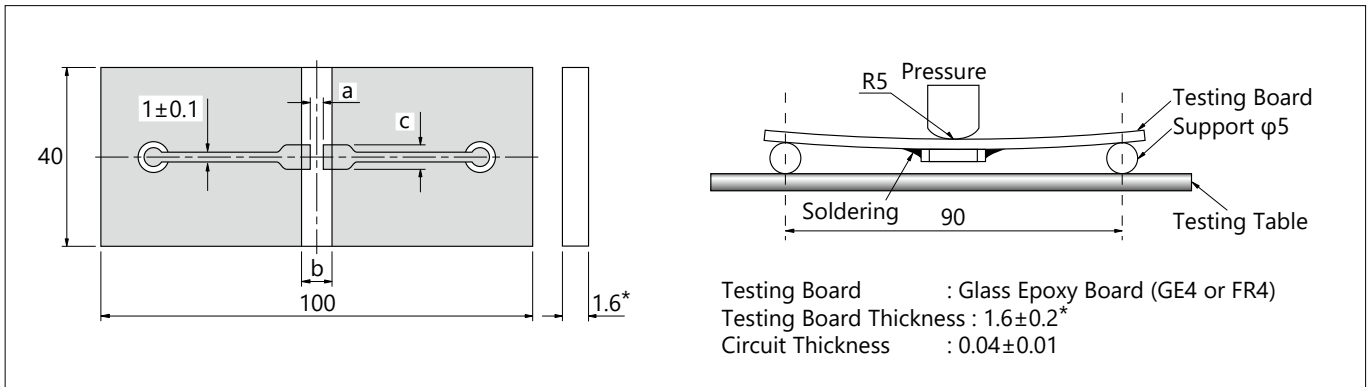

\*02, 03, 05 size  $0.8 \pm 0.1$ mm

### Structure

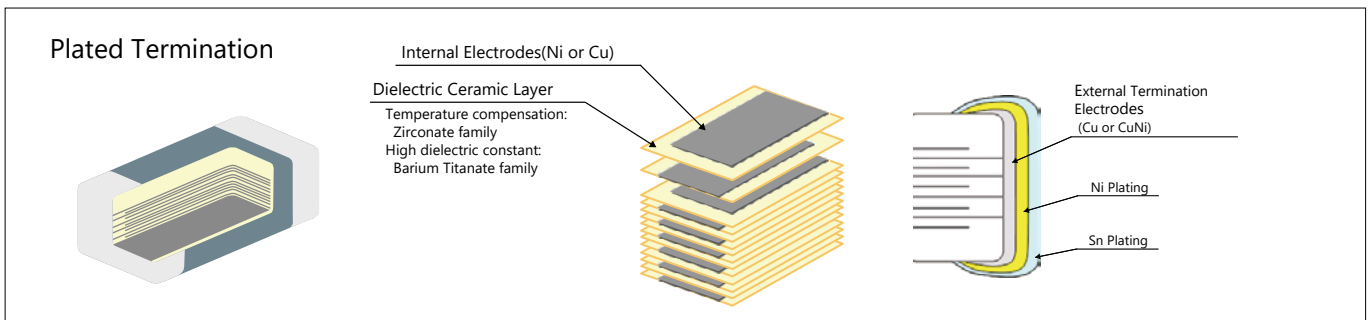

#### ■ Certification status

<ISO>

Acquired ISO 9001 quality management system certification.

<IATF>

Acquired IATF 16949 quality management system certification.

#### ■ Production plant

Kagoshima Kokubu plant

## Packaging Options Tape and Reel

### Reel

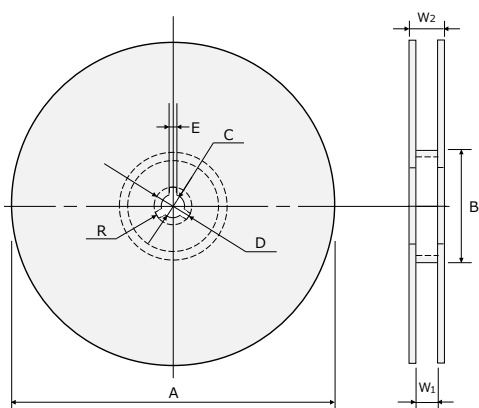

(Unit: mm)

Code Reel	A	B	C	D
7-inch Reel (CODE: T, H, Q, U)	180 <sup>+0</sup> <sub>-2.0</sub>	φ60 min.	13±0.5	21±0.8
7-inch Reel (CODE: P)	178±2.0			
13-inch Reel (CODE: L, M, N, W)	330±2.0			
Code Reel	E	W <sub>1</sub>	W <sub>2</sub>	R
7-inch Reel (CODE: T, H, Q, U)	2.0±0.5	10.5±1.5	16.5 max.	1.0
7-inch Reel (CODE: P)		4.35±0.3	6.95±1.0	
13-inch Reel (CODE: L, M, N, W)		9.5±1.0	16.5 max.	

### Carrier Tape

(Unit: mm)

F=1mm (02 Size)

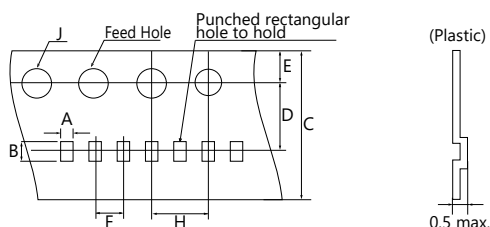

F=2mm (02, 03, 05 Size)

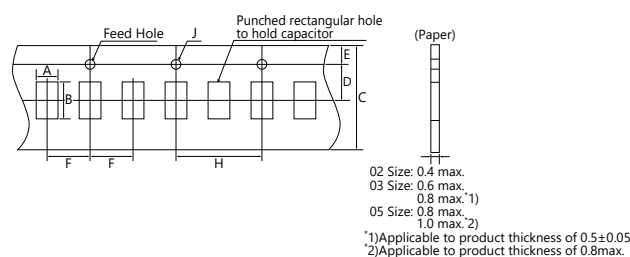

F=1mm (03 Size)

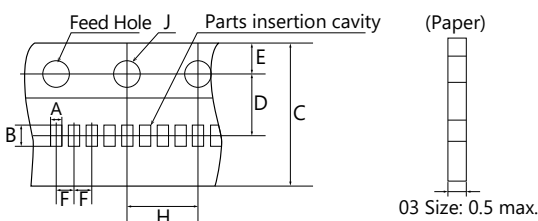

F=4mm (15, 21, 31, 32 Size)

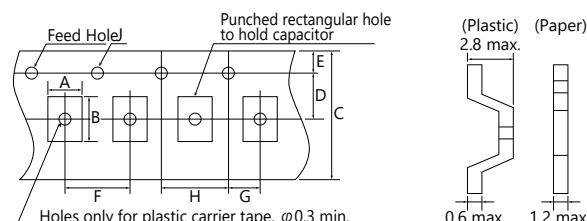

(Unit: mm)

Size (EIA Code)	A	B	C	D	E	F	G	H	J	Carrier Tape	
										Width	Material
02 (01005)*	0.24±0.02	0.44±0.02	4.0±0.08	1.8±0.02	0.9±0.05	1.0±0.02	—	2.0±0.04	0.8±0.04	4	Plastic
	0.25±0.03	0.45±0.03	8.0±0.3	3.5±0.05	1.75±0.1	2.0±0.05		4.0±0.1	1.5±0.1/-0	8	Paper
03 (0201)*	0.37±0.03	0.67±0.03	8.0+0.3/-0.1	3.5±0.05	1.75±0.1	1.0±0.05	—	4.0±0.05	1.5±0.1/-0	8	Paper
	0.39±0.03	0.69±0.03	8.0±0.3	3.5±0.05	1.75±0.1	2.0±0.05		4.0±0.1	1.5±0.1/-0		
	0.42±0.03	0.72±0.03	8.0±0.3	3.5±0.05	1.75±0.1	2.0±0.05		4.0±0.1	1.5±0.1/-0		
	0.44±0.05	0.74±0.05	8.0±0.3	3.5±0.05	1.75±0.1	2.0±0.05		4.0±0.1	1.5±0.1/-0		
05 (0402)*	0.65±0.1	1.15±0.1	8.0±0.3	3.5±0.05	1.75±0.1	2.0±0.05	—	4.0±0.1	1.5±0.1/-0	8	Paper
	0.75±0.1										
	0.8±0.1										
15 (0603)*	1.0±0.2	1.8±0.2	8.0±0.3	3.5±0.05	1.75±0.1	4.0±0.1	2.0±0.05	4.0±0.1	1.5±0.1/-0	8	Paper
	1.1±0.2	1.9±0.2	8.0±0.3	3.5±0.05	1.75±0.1	4.0±0.1	2.0±0.05	4.0±0.1	1.5±0.1/-0		
21 (0805)	1.5±0.2	2.3±0.2	8.0±0.3	3.5±0.05	1.75±0.1	4.0±0.1	2.0±0.05	4.0±0.1	1.5±0.1/-0	8	Plastic
										8	Paper
31 (1206)	2.0±0.2	3.6±0.2	8.0±0.3	3.5±0.05	1.75±0.1	4.0±0.1	2.0±0.05	4.0±0.1	1.5±0.1/-0	8	Paper
										8	Plastic
32 (1210)	2.9±0.2	3.6±0.2	8.0±0.3	3.5±0.05	1.75±0.1	4.0±0.1	2.0±0.05	4.0±0.1	1.5±0.1/-0	8	Plastic

\* Option

## Packaging Options

### Detail of leader and trailer

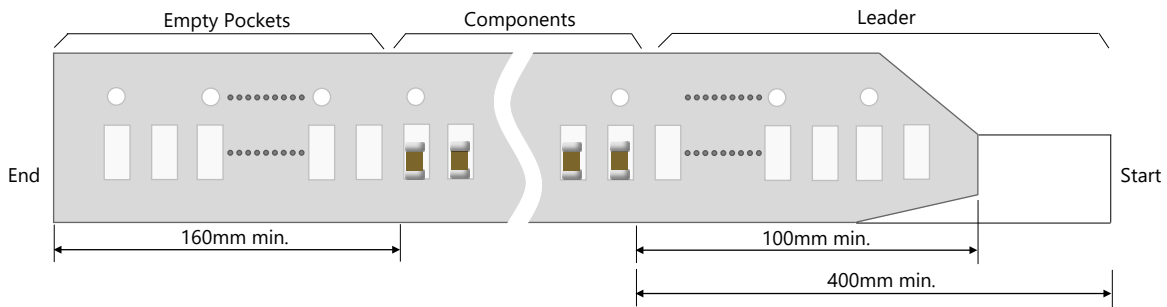

### Adhesive tape

- 1) The exfoliative strength when peeling off the top tape from the carrier tape by the method of the following figure shall be \*0.1 to 0.7N. \*02 Size: 0.1 to 0.5N
- 2) When the top tape is peeled off, the adhesive stays on the top tape.
- 3) Chip capacitors will be in a state free without being stuck on the thermal adhesive tape.

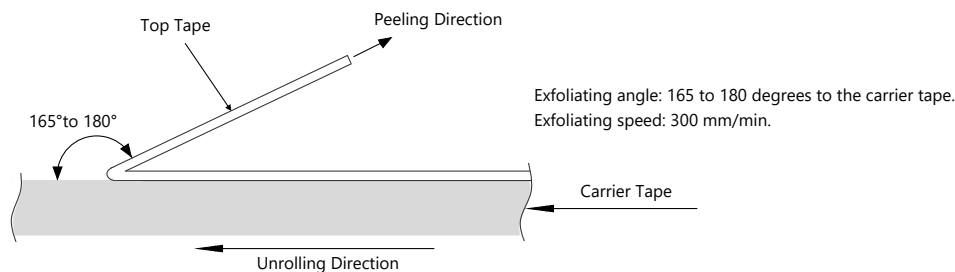

### Carrier tape

- 1) Chip will not fall off from carrier tape or carrier tape will not be damaged by bending than within a radius of 25mm.
- 2) The chip are inserted continuously without any empty pocket.
- 3) Chip will not be mis-mounted because of too big clearance between components and cavity. Also the waste of carrier tape will not fill a nozzle hole of mounting machine.

## Surface Mounting Information

### Dimensions for recommended typical land

Since the amount of solder (size of fillet) to be used has direct influence on the capacitor after mounting, the sufficient consideration is necessary.

When the amounts of solder is too much, the stress that a capacitor receives becomes larger. It may become the cause of a crack in the capacitor. When the land design of printed wiring board is considered, it is necessary to set up the form and size of land pattern so that the amount of solder is suitable.

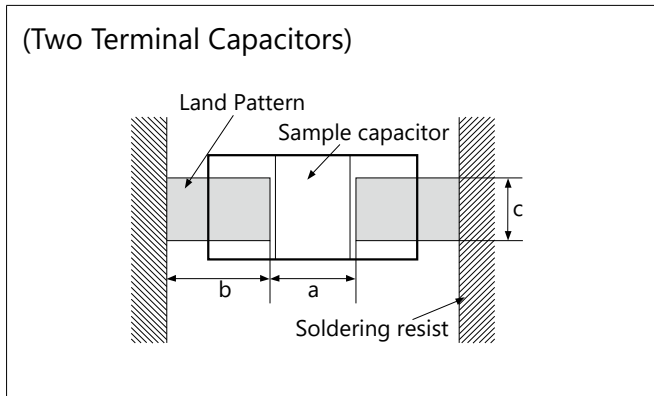

### Two Terminal Capacitors

(Unit: mm)

Size (EIA Code)	Dimension		Recommended land dimensions		
	L	W	a	b	c
02 (01005)	0.4±0.02	0.2±0.02	0.13 to 0.2	0.12 to 0.18	0.2 to 0.23
03 (0201)	0.6±0.03	0.3±0.03	0.2 to 0.25	0.25 to 0.35	0.3 to 0.4
	0.6±0.05	0.3±0.05			
	0.6±0.09	0.3±0.09	0.23 to 0.3	0.25 to 0.35	0.3 to 0.45
05 (0402)	1.0±0.05	0.5±0.05	0.3 to 0.5	0.35 to 0.45	0.4 to 0.6
	1.0±0.15	0.5±0.15			
	1.0±0.2	0.5±0.2	0.4 to 0.6	0.4 to 0.5	0.5 to 0.75
15 (0603)	1.6±0.1	0.8±0.1	0.7 to 1.0	0.8 to 1.0	0.6 to 0.9
	1.6±0.2	0.8±0.2	0.8 to 1.0	0.8 to 1.0	0.8 to 1.1
21 (0805)	2.0±0.2	1.25±0.2	1.0 to 1.3	1.0 to 1.2	1.25 to 1.55
	3.2±0.2	1.6±0.15	2.1 to 2.5	1.1 to 1.3	1.4 to 1.9
31 (1206)	3.2±0.2	1.6±0.2	2.1 to 2.5	1.1 to 1.3	1.6 to 2.0
	3.2±0.3	1.6±0.3			
	3.2±0.3	1.6±0.3	2.1 to 2.5	1.1 to 1.3	1.6 to 2.0
32 (1210)	3.2±0.3	2.5±0.2	2.1 to 2.5	1.1 to 1.3	1.9 to 2.8

\* Recommended land dimensions may differ depending on dimensional tolerance.

### Design of printed circuit and Soldering

The recommended fillet height shall be 1/2 of the thickness of capacitors or 0.5mm. When mounting two or more capacitors in the common land, it is necessary to separate the land with the solder resist strike so that it may become the exclusive land of each capacitor.

### Ideal Solder Height

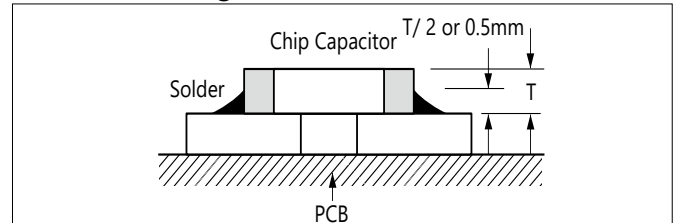

Item	Prohibited	Recommended example : Separation by solder resist
Multiple parts mount		
Mount with leaded parts		
Wire soldering after mounting		
Side by side layout		



## Surface Mounting Information

### Actual Mounting

- 1) If the position of the vacuum nozzle is too low, a large force may be applied to the chip capacitor during mounting, resulting in cracking.
- 2) During mounting, set the nozzle pressure to a static load of 1 to 3 N.
- 3) To minimize the shock of the vacuum nozzle, provide a support pin on the back of the PCB to minimize PCB flexure.
- 4) Bottom position of pick up nozzle should be adjusted to the top surface of a substrate which camber is corrected.

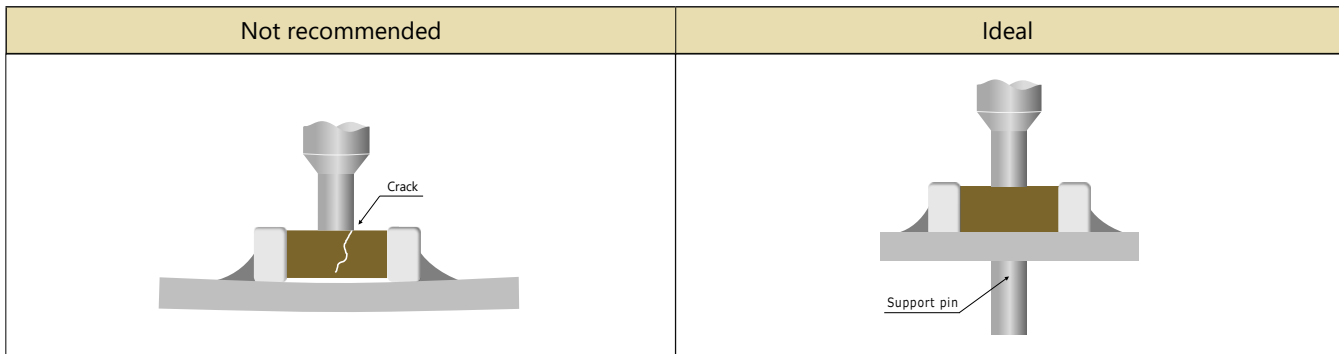

### Mounting Design

The chip could crack if the PCB warps during processing after the chip has been soldered.

Recommended chip position on PCB to minimize stress from PCB warpage

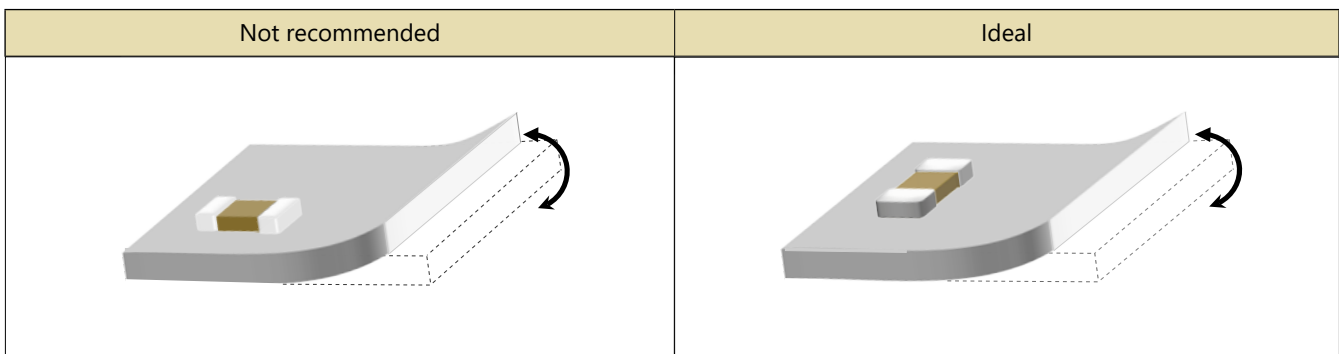

### Soldering Method

- 1) Ceramic is easily damaged by rapid heating or cooling. If some heat shock is unavoidable, preheat enough to limit the temperature difference (Delta T) to within 150 degree Celsius.
- 2) The product size 1.6×0.8mm to 3.2×1.6mm can be used in reflow and wave soldering, and the product size of bigger than 3.2×1.6mm, or smaller than 1.6×0.8mm can be used in reflow.  
Circuit shortage and smoking can be created by using capacitors which are used neglecting the above caution.
- 3) Please see our recommended soldering conditions.
- 4) In case of using Sn-Zn Solder, please contact us in advance.
- 5) The following condition is recommended for spot heater application.

· Recommended spot heater condition

Item	Condition
Distance	5mm min.
Angle	45°
Projection Temp.	400°C max.
Flow rate	Set at the minimum
Nozzle diameter	2φ to 4φ (Single hole type)
Application time	10 sec. max. (1206 and smaller) 30 sec. max. (1210 and larger)

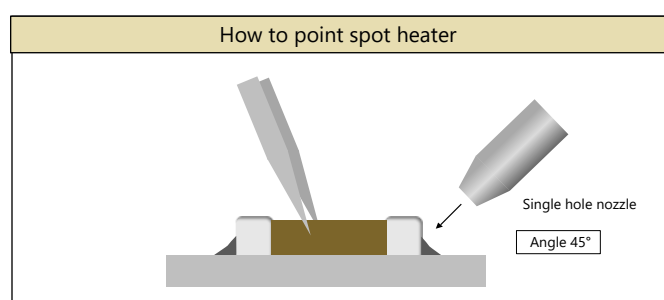

## Surface Mounting Information

### Recommended Temperature Profile (Sn-3Ag-0.5Cu)

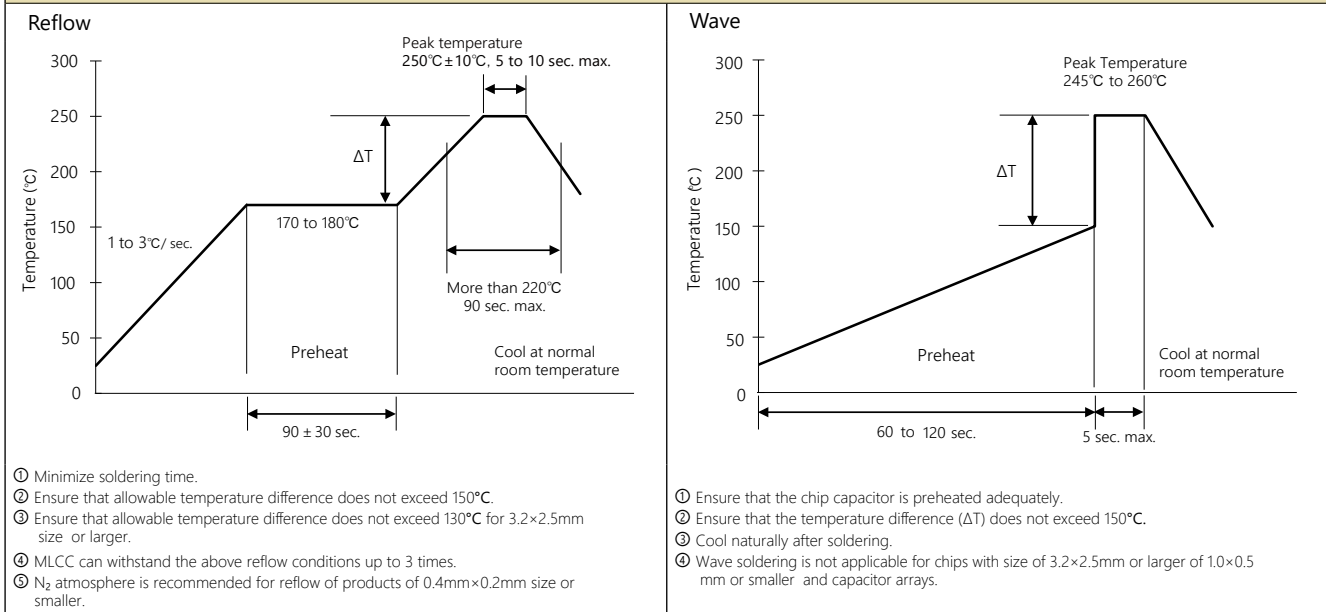

### Resin Mold

- 1) If a large amount of resin is used for molding the chip, cracks may occur due to contraction stress during curing. To avoid such cracks, use a low shrinkage resin.
- 2) The insulation resistance of the chip will degrade due to moisture absorption. Use a low moisture absorption resin.
- 3) Check carefully that the resin does not generate a decomposition gas or reaction gas during the curing process or during normal storage. Such gases may crack the chip capacitor or damage the device itself.

## Precautions

### Circuit Design

1. Once application and assembly environments have been checked, the capacitor may be used in conformance with the rating and performance which are provided in both the catalog and the specifications. Use exceeding that which is specified may result in inferior performance or cause a short, open, smoking, or flaming to occur, etc.
2. Please consult the manufacturer in advance when the capacitor is used in devices such as: devices which deal with human life, i.e. medical devices; devices which are highly public orientated; and devices which demand a high standard of liability.  
Accident or malfunction of devices such as medical devices, space equipment and devices having to do with atomic power could generate grave consequence with respect to human lives or, possibly, a portion of the public. Capacitors used in these devices may require high reliability design different from that of general purpose capacitors.
3. Please use the capacitors in conformance with the operating temperature provided in both the catalog and the specifications.  
Be especially cautious not to exceed the maximum temperature. In the situation the maximum temperature set forth in both the catalog and specifications is exceeded, the capacitor's insulation resistance may deteriorate, power may suddenly surge and short-circuit may occur.  
The capacitor has a loss, and may self-heat due to equivalent series resistance when alternating electric current is passed therethrough. As this effect becomes especially pronounced in high frequency circuits, please exercise caution.  
When using the capacitor in a (self-heating) circuit, please make sure the surface of the capacitor remains under the maximum temperature for usage. Also, please make certain temperature rises remain below 20°C.
4. Please keep voltage under the rated voltage which is applied to the capacitor. Also, please make certain the peak voltage remains below the rated voltage when AC voltage is super-imposed to the DC voltage.  
In the situation where AC or pulse voltage is employed, ensure average peak voltage does not exceed the rated voltage.  
Exceeding the rated voltage provided in both catalog and specifications may lead to defective withstanding voltage or, in worst case situations, may cause the capacitor to smoke or flame.
5. When the capacitor is to be employed in a circuit in which there is continuous application of a high frequency voltage or a steep pulse voltage, even though it is within the rated voltage, please inquire to the manufacturer.  
In the situation the capacitor is to be employed using a high frequency AC voltage or a extremely fast rising pulse voltage, even though it is within the rated voltage, it is possible capacitor reliability will deteriorate.
6. It is a common phenomenon of high-dielectric products to have a deteriorated amount of static electricity due to the application of DC voltage.  
Due caution is necessary as the degree of deterioration varies depending on the quality of capacitor materials, capacity, as well as the load voltage at the time of operation.
7. Do not use the capacitor in an environment where it might easily exceed the respective provisions concerning shock and vibration specified in the catalog and specifications.  
In addition, it is a common piezo phenomenon of high dielectric products to have some voltage due to vibration or to have noise due to voltage change. Please contact sales in such case.
8. If the electrostatic capacity value of the delivered capacitor is within the specified tolerance, please consider this when designing the respective product in order that the assembled product function appropriately.
9. Please contact us upon using conductive adhesives.

### Storage

Please note the following regarding the storage of delivered products.

1. Set the storage temperature to + 5 to + 40 °C and humidity to 20 ~ 70% RH. Other meteorological conditions are in accordance with classification 1 K2 of JIS C 60721 -3 -1.
2. Store in a place where corrosive gas (H<sub>2</sub>S, SO<sub>2</sub>, NO<sub>2</sub>, Cl<sub>2</sub>, etc.) does not exist in the atmosphere. Also, avoid exposure to salty moisture. In either case, this may cause oxidation corrosion of the terminal electrode, reducing solderability.

If you store the above delivered products according to the conditions listed above, it will satisfy the solderability standard for 6 months from the shipping date.

Safety application guideline and detailed information of electrical properties are also provided in kyocera web site;

URL: <https://ele.kyocera.com/en/product/capacitor/>



## Notes for Using the Catalog

1. Specifications described in this catalog are for references. Products specifications shall be based on written documents agreed by each party.
2. Contents in this catalog are subject to change without notice. It is recommended to confirm the latest information at the time of usage. Also, Kyocera Electronic Components Catalog is revised once a year. We may not be able to accept requests based on old catalogs.
3. Products in this catalog are intended to be used in general electronic equipment such as office equipment, audio and visual equipment, communication equipment, measurement instrument and home appliances. It is absolutely recommended to consult with our sales representatives in advance upon planning to use our products in applications which require extremely high quality and reliability such as aircraft and aerospace equipment, traffic systems, safety systems, power plant and medical equipment including life maintenance systems.
4. Even though we strive for improvements of quality and reliability of products, it is requested to design with enough safety margin in equipment or systems in order not to threaten human lives directly or damage human bodies or properties by an accidental result of products.
5. It is requested to design based on guaranteed specifications for such as maximum ratings, operating voltage and operating temperature. It is not the scope of our guarantee for unsatisfactory results due to misuse or inadequate usage of products in the catalog.
6. Operation summaries and circuit examples in this catalog are intended to explain typical operation and usage of the product. It is recommended to perform circuit and assembly design considering surrounding conditions upon using products in this catalog.
7. Technical information described in this catalog is meant to explain typical operations and applications of products, and it is not intended to guarantee or license intellectual properties or other industrial rights of the third party or Kyocera.
8. Trademarks, logos and brand names used in this catalog are owned by Kyocera or the corresponding third party.
9. Certain products in this catalog are subject to the Foreign Exchange and Foreign Trade Control Act of Japan, and require the license from Japanese Government upon exporting the restricted products and technical information under the law.  
Besides, it is requested not to use products and technical information in the catalog for the development and/or manufacture of weapons of mass destruction or other conventional weapons, nor to provide them to any third party with the possibility of having such purposes.
10. It is prohibited to reprint and reproduce a part or whole of this catalog without permission.
11. Contents described herein are as of January 2024.